

# EXACTECH | SHOULDER

Operative Technique



**equinox<sup>®</sup>**

Platform Fracture Stem  
Shoulder System

# TABLE OF CONTENTS

<b>INTRODUCTION</b> .....	1	<b>PRE-OPERATIVE PLANNING</b> .....	19
<b>SYSTEM SPECIFICATIONS</b> .....	2	PATIENT POSITIONING .....	19
<b>HEMIARTHROPLASTY OVERVIEW TECHNIQUE</b> .....	4	SURGICAL APPROACH.....	19
<b>1. HEMIARTHROPLASTY</b>		Deltpectoral Approach .....	19
<b>DETAILED OPERATIVE TECHNIQUE</b> .....	6	Superiolateral Approach.....	19
INDICATIONS FOR USE .....	6	PREPARING THE GLENOID.....	19
CONTRAINDICATIONS FOR USE .....	6	Glenoid Exposure.....	19
<b>PRE-OPERATIVE PLANNING</b> .....	7	Reaming the Glenoid .....	20
PATIENT POSITIONING .....	7	Pilot-Tip Reamers.....	21
SURGICAL APPROACH.....	8	Cannulated Reamers.....	22
HUMERAL PREPARATION .....	9	Drill Cage Hole through Drill Guide.....	22
Fracture Stem Trialing .....	9	Bone Graft for Glenoid Plate .....	22
Retroversion—Distal Portion		Implanting the Glenoid Plate.....	23
of Bicipital Groove (Visible).....	9	Inserting the Glenosphere Trial .....	25
Retroversion—Distal Portion		HUMERAL PREPARATION.....	28
of Bicipital Groove (Not Visible) .....	9	Fracture Stem Trialing .....	28
HUMERAL HEAD TRIAL		Retroversion—Distal Portion of	
AND TRIAL REDUCTION .....	10	Bicipital Groove (Visible) .....	28
Humeral Stem Height .....	10	Retroversion—Distal Portion of	
Attaching the Replicator to the Plate Trial.....	10	Bicipital Groove (Not Visible) .....	28
Humeral Head Trial .....	10	Trialing the Humeral Adapter Tray	
Trial Reduction.....	10	and Liner .....	29
REDUCTION WITH DEFINITIVE IMPLANT .....	11	REDUCTION WITH DEFINITIVE IMPLANT.....	31
Cementing the Fracture Stem .....	11	Cementing the Fracture Stem .....	31
Tuberosity Fixation.....	12	<b>CLOSURE</b> .....	33
Tuberosity Reattachment.....	12	DELTOPECTORAL CLOSURE.....	33
Suturing Technique for Right Shoulder .....	13	SUPERIOR-LATERAL CLOSURE .....	33
Humeral Head Attachment .....	13	GLENSPHERE REMOVAL .....	33
Tying the Sutures.....	14	<b>POST-OPERATIVE REHABILITATION</b> .....	33
Final Stable Reconstruction .....	14	<b>3. REVISING A HEMIARTHROPLASTY</b>	
POST-OPERATIVE REHABILITATION .....	15	<b>TO A REVERSE</b> .....	34
POST-OPERATIVE RANGE OF MOTION .....	15	<b>EQUINOXE IMPLANT SCOPE</b> .....	36
<b>FRACTURE REVERSE OVERVIEW TECHNIQUE</b> .....	16	<b>EQUINOXE PLATFORM STEM</b>	
<b>2. FRACTURE REVERSE</b>		<b>INSTRUMENT LISTING</b> .....	38
<b>DETAILED OPERATIVE TECHNIQUE</b> .....	18	<b>REFERENCES</b> .....	43
INDICATIONS FOR USE .....	18		
CONTRAINDICATIONS FOR USE .....	18		

## EQUINOXE® PLATFORM FRACTURE STEM DESIGN TEAM:

**Pierre-Henri Flurin, MD**  
*Surgical Clinic of Bordeaux, Mergnac (France)*

**Sean Grey, MD**  
*Orthopaedic Center of the Rockies*

**Richard B. Jones, MD**  
*Southeastern Sports Medicine*

**Howard D. Routman, DO**  
*Atlantis Orthopaedics*

**Thomas W. Wright, MD**  
*University of Florida*

**Joseph D. Zuckerman, MD**  
*NYU Hospital for Joint Diseases*

## INTRODUCTION

The Equinox<sup>®</sup> Shoulder System redefines “anatomical.” The primary stem allows independent adjustability of all four anatomic parameters *in situ*. The reverse shoulder is an optimized design that minimizes both scapular notching and torque on the glenoid while seamlessly integrating with the primary and platform fracture stems. The platform fracture stem’s offset anterior-lateral fin and asymmetric tuberosity beds define the next generation in complex fracture reconstruction. The platform nature of the Equinox primary and fracture stems allows the surgeon to have intra-operative flexibility to choose between a hemiarthroplasty, primary total shoulder or reverse total shoulder and seamlessly convert to a reverse should a revision become necessary.

Throughout the development process, our team has collaborated on every facet of the Equinox Shoulder System including this operative technique. We have taken a comprehensive approach to the technique, discussing the surgery from pre-operative planning to post-operative rehabilitation, since many shoulder replacements are performed by surgeons who may only do two to three per year. Obviously, there are myriad approaches to each step of shoulder arthroplasty and the surgeon should feel free to employ those with which he/she is most comfortable. The Equinox-specific techniques, though, should be respected to help ensure a safe and successful surgery.

We began this product development process by identifying the need for surgeons to occasionally treat complex fractures in the elderly with a reverse shoulder and the need to occasionally make an intra-operative decision whether to treat a patient with either a reverse or a hemiarthroplasty. We believe the Equinox Platform Fracture Stem

significantly improves the surgeon’s ability to secure the tuberosities. The asymmetric beds act as a scaffold for the stable reconstruction of the fractured fragments. The offset anterior-lateral fin, when placed in the distal bicipital groove, assists the surgeon in correctly establishing retroversion and the stem works seamlessly with our reverse shoulder implants so a surgeon can treat acute fractures with either a hemiarthroplasty or a reverse without removing the stem.

We offer this operative technique in two different formats. The first is a high-level overview intended as a refresher before surgery or as a guide for the surgeon’s support staff. The detailed narrative version is intended for an in-depth understanding of the step-by-step approach that our team has endorsed and should be read at least once before using the Equinox Shoulder System.

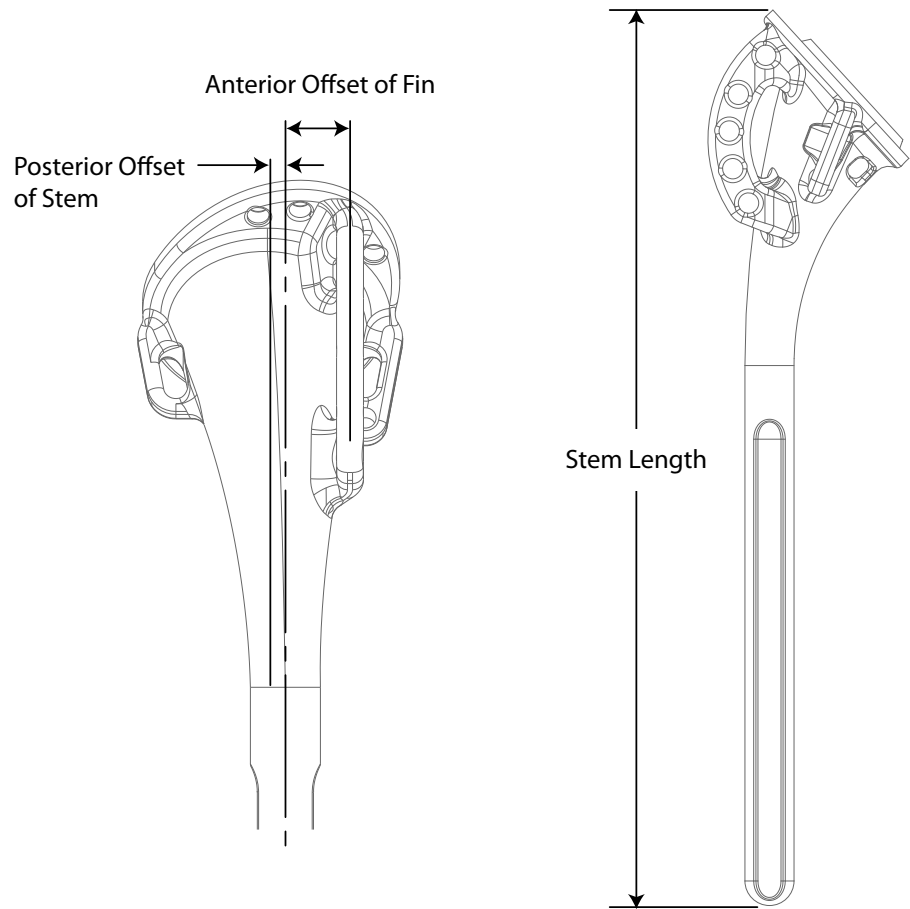
We hope that our work, both the technique and the Equinox Shoulder System, will facilitate “*A Great Day in the O.R.*” for the surgeon and the staff.

Respectfully,

**Pierre-Henri Flurin, MD**  
**Sean Grey, MD**  
**Richard B. Jones, MD**  
**Howard D. Routman, DO**  
**Thomas W. Wright, MD**  
**Joseph D. Zuckerman, MD**

# SYSTEM SPECIFICATIONS

(All dimensions in millimeters)

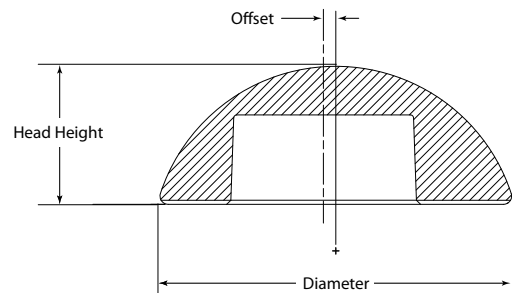


## FRACTURE STEM

Distal Diameter	Length	Sides	Material	Surface Finish			Inherent Posterior Offset	Anterior Offset of Fin
				Tuberosity Beds	Remainder of Stem	Suture Holes		
6.5	120 & 200	Rights & Lefts	Ti-6Al-4V	16 grade grit blast	Satin finish High bright polish	Rounded to avoid breakage	1.8	6.0
8.5	140						1.8	7.5
10.5							1.8	7.5
12.5							1.8	7.5

## HUMERAL HEADS

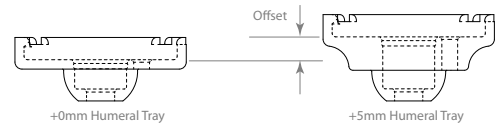
Diameter (mm)	Height (mm)			Offset (mm)	Material
	Short	Tall	Expanded		
38	16	19		0	Co-Cr
41	16	20		0	
44	17	21		1.5	
47	18	22	26	1.5	
50	19	23	27	1.5	
53	20	24	28	1.5	



## HUMERAL TRAY/HUMERAL LINER OFFSET COMPARISONS

	+0mm Humeral Liners (Standard and Constrained)	+2.5mm Humeral Liners (Standard and Constrained)
+0 Humeral Tray	0	2.5
+5 Humeral Tray	5	7.5
+10 Humeral Tray	10	12.5
+15 Humeral Tray*	15	17.5

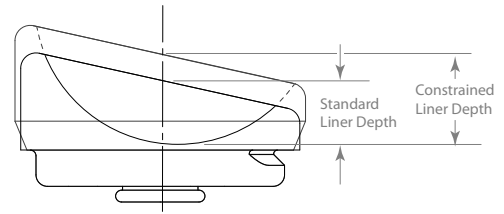
\* special order



## HUMERAL LINER DEPTH COMPARISONS

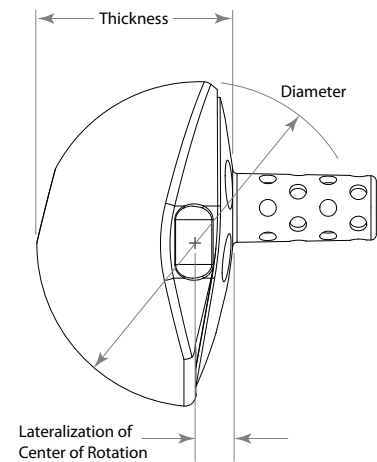
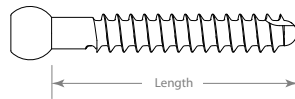
	Standard Liner Depth (+0mm and +2.5mm)	Constrained Liner Depth (+0mm and +2.5mm)
38 Humeral Liners	8.5	12.0
42 Humeral Liners	8.8	12.6
46 Humeral Liners*	8.9	13.1

\* special order



## COMPRESSION SCREWS

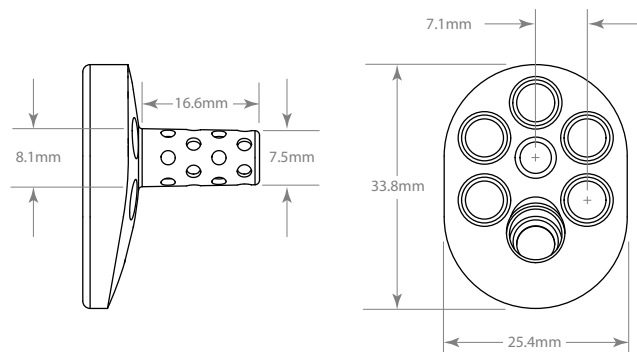
Diameter	Length	Color
4.5	18	White
	22	Black
	26	Orange
	30	Blue
	34	Red
	38	Green
	42	Yellow
	46	Purple



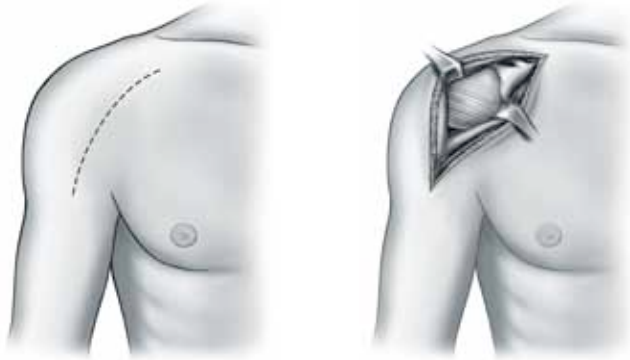
## GLENOSPHERE/GLENOID PLATE

	Diameter	Thickness	Average Lateralization of Center of Rotation
38 Glenosphere	38	23.1	2
42 Glenosphere	42	25.1	
46 Glenosphere*	46	27.1	2

\* special order



# HEMIARTHROPLASTY OVERVIEW TECHNIQUE



**A** Incision and Exposure



**B** Insert Reamer



**C** Align Fin to Bicipital Groove



**D** Insert Fracture Stem Trial



**E** Maintain Height



**F** Attach Replicator Plate Trial



**G** Align Humeral Head Trial



**H** Drill Pilot Holes for Attaching Vertical Sutures





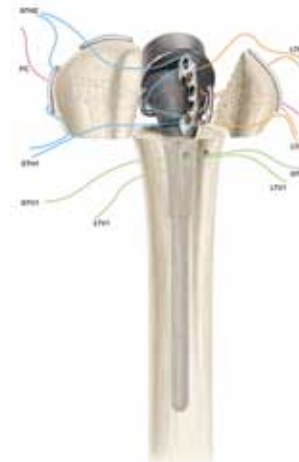
**I** Lock Torque-Defining Screw



**J** Insert Final Prosthesis



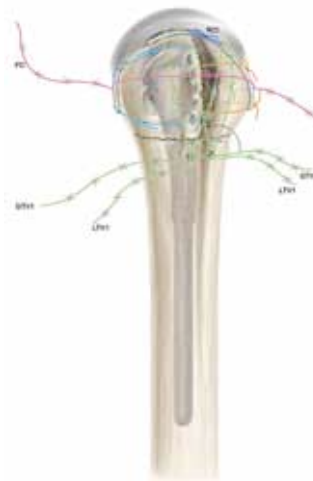
**K** Tuberosity Reattachment



**L** Place GT and LT Horizontal Sutures (GTH and LTH) and Final Cerclage (FC)



**M** Tie Horizontal Sutures then Place and Tie Cuff Interval Suture (RCI)



**N** Tie LT Vertical Suture and then Tie GT Vertical Suture



**O** Tie Final Cerclage

# TECHNIQUE OUTLINE OVERVIEW FOR RIGHT SHOULDER

1. Hemiarthroplasty
2. Fracture Reverse
3. Revising Hemiarthroplasty to Reverse

## 1. HEMIARTHROPLASTY DETAILED OPERATIVE TECHNIQUE

### INDICATIONS FOR USE

The Equinox Shoulder System is indicated for use in skeletally mature individuals with degenerative diseases or fractures of the glenohumeral joint where total or hemiarthroplasty is determined by the surgeon to be the preferred method of treatment.

- The cemented primary humeral stem, long/revision stem, fracture stems and all Equinox glenoids are intended for cemented fixation.
- The press-fit humeral stems are intended for press-fit applications but may be used with bone cement at the discretion the surgeon.
- The reverse humeral components are intended to be used in cemented applications or in revision cases when the humeral component is well-fixed/stable, as deemed by the orthopaedic surgeon.
- Humeral Heads are intended for use in cemented and press-fit applications.

Clinical indications for the PRIMARY (P), LONG/REVISION (L), and FRACTURE (F) humeral components are as follows:

P	L	F	Indications
√	√		Rheumatoid arthritis, osteoarthritis, osteonecrosis or post-traumatic degenerative problems
√	√		Congenital abnormalities in the skeletally mature
√			Primary and secondary necrosis of the humeral head
√		√	Humeral head fracture with displacement of the tuberosities
√	√		Pathologies where arthrodesis or resectional arthroplasty of the humeral head are not acceptable
√	√		Revisions of humeral prostheses when other treatments or devices have failed (where adequate fixation can be achieved)

		√	Displaced three-part and four-part upper humeral fractures
	√		Spiral and other fractures of the mid-humerus (in combination with glenohumeral degenerative diseases)
	√		Revision of failed previous reconstructions when distal anchorage is required
√	√		To restore mobility from previous procedures (e.g. previous fusion)

The Equinox Reverse Shoulder System is indicated for use in skeletally mature individuals with degenerative diseases of the glenohumeral joint and a grossly deficient, irreparable rotator cuff. The Equinox Reverse Shoulder is also indicated for a failed glenohumeral joint replacement with loss of rotator cuff function resulting in superior migration of the humeral head.

The Equinox Platform Fracture Stem is indicated for use in skeletally mature individuals with acute fracture of the proximal humerus and displacement of the tuberosities, displaced three- and four-part fractures of the proximal humerus (hemi-arthroplasty), or acute fracture of the proximal humerus with failure of the glenohumeral joint (primary total shoulder arthroplasty). The Equinox Platform Fracture Stem is also indicated for acute fracture of the proximal humerus in combination with degenerative diseases of the glenohumeral joint and a grossly deficient, irreparable rotator cuff resulting in superior migration of the humeral head (reverse total shoulder arthroplasty). The Equinox Platform Fracture Stem is indicated for cemented use only.

### CONTRAINDICATIONS FOR USE

Use of the Equinox Shoulder System is contraindicated in the following situations:

- Osteomyelitis of the proximal humerus or scapula; if a systemic infection or a secondary remote infection is suspected or confirmed, implantation should be delayed until infection is resolved.
- Inadequate or malformed bone that precludes adequate support or fixation of the prosthesis.
- Neuromuscular disorders that do not allow control of the joint.
- Significant injury to the brachial plexus.
- Non-functional deltoid muscles.
- Patient's age, weight, or activity level would cause the surgeon to expect early failure of the system.
- The patient is unwilling or unable to comply with the post-operative care instructions.
- Alcohol, drug, or other substance abuse.
- Any disease state that could adversely affect the function or longevity of the implant.



## PRE-OPERATIVE PLANNING

The decision to proceed with proximal humeral replacement should reflect a careful consideration of both injury and patient factors. An important injury factor is the degree of tuberosity displacement; it indicates the degree of soft-tissue injury and is associated with an increased risk of osteonecrosis. The degree of comminution and bone quality also are important factors that may prevent optimal fixation.

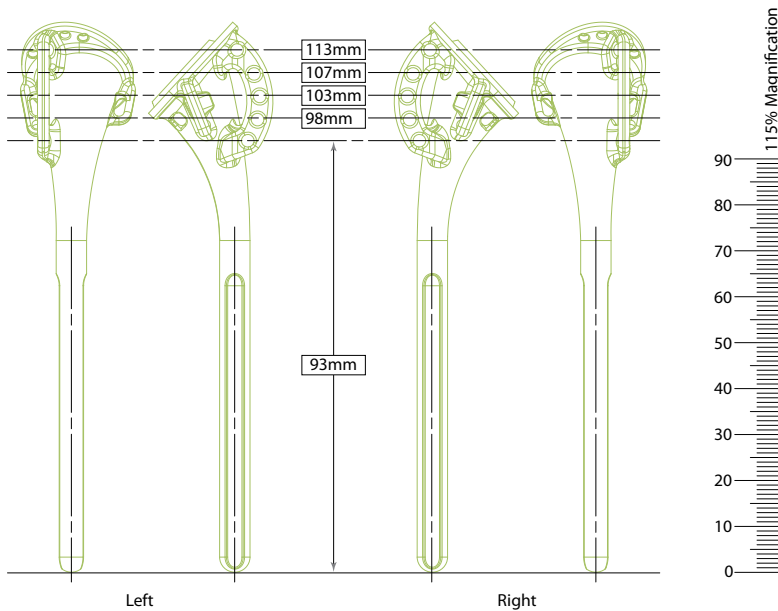
Important patient factors include the age and functional needs of the patient. Additionally, the presence of pre-existing functional deficits in the involved extremity must be considered in the decision to proceed with a reconstructive procedure. Patients must be able to participate in a structured post-operative rehabilitative program, which is essential for a successful outcome.

Establishing the appropriate humeral head height and humeral length is a challenge in reconstructing four-part proximal fractures. The most common pre-operative method to evaluate humeral head height in the fractured shoulder is by comparison to the contralateral humerus in an A/P radiograph.

Once the appropriate head height is established, mark the A/P radiograph with the anticipated location of the humeral head using the Equinox surgical templates (*Surgical Template*). Define the height level of the humeral stem relative to the fracture line. Additionally, assess the appropriate stem diameter relative to the canal diameter; each stem has a 0.5mm cement mantle when used with the appropriate reamer. It is also important to know that the fin holes on the trial correspond to the fin holes on the definitive implant.

### PATIENT POSITIONING

The patient should be placed on an operating table in a supine position. The head of the operating table should be elevated approximately 30 degrees in a modified beach chair position. A small bolster is placed behind the involved scapula. The patient should be moved to the side of the table so that the upper extremity can be placed into maximum extension without obstruction by the operating table. Alternatively, a Captain's chair or similar positioning device can be used for proper patient positioning. The patient should be secured to the operating table to minimize any changes in position intra-operatively. The entire upper extremity should be prepped and draped to allow full mobility during the procedure.



**Surgical Template**  
X-Ray Template 6.5mm Platform Fracture Stem

## SURGICAL APPROACH

A straight deltopectoral incision is made beginning just lateral to the tip of the coracoid process and extending distally and laterally to the insertion of the deltoid. The subcutaneous tissues are divided and medial and lateral flaps are elevated to expose the deeper muscular layers (*Figure 1*).

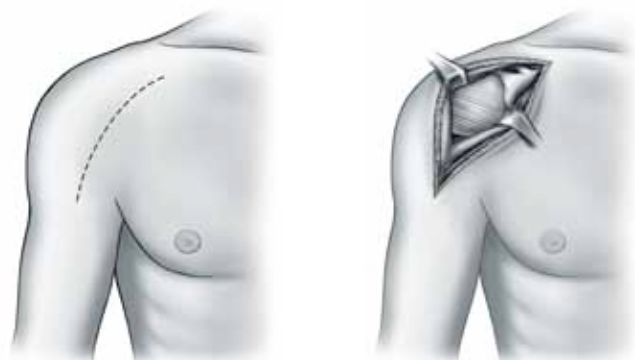
The deltopectoral interval is identified by localization of the cephalic vein. The cephalic vein is usually retracted laterally with the deltoid muscle. In some instances the cephalic vein is more easily retracted medially with the pectoralis major. In either case, care should be taken to preserve the cephalic vein throughout the procedure.

The subdeltoid space is mobilized, as is the pectoralis major. The conjoined tendon muscles are identified and the clavipectoral fascia is divided at the medial edge of the conjoined tendon muscles. The fracture hematoma is usually evident after dividing the clavipectoral fascia. The conjoined tendon muscles and the pectoralis major are retracted medially and the deltoid is retracted laterally. This can be most easily accomplished with the use of a self-retaining type of retractor. After the fracture hematoma has been evacuated, the deeper structures can be visualized. The biceps tendon should be identified and tagged with a suture. The biceps tendon provides an orientation to the greater and lesser tuberosities.

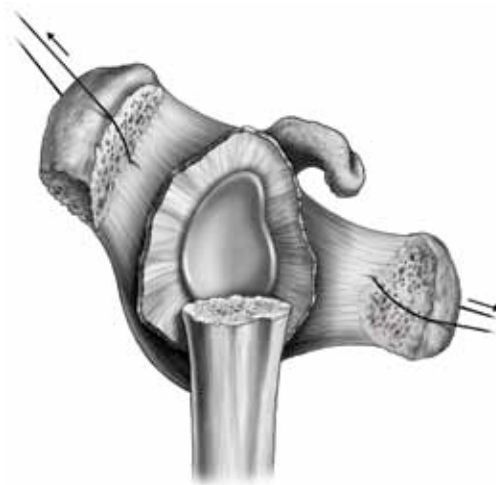
The lesser tuberosity is located medial to the biceps tendon and the greater tuberosity is located superiorly and laterally. Each tuberosity should be tagged with a #2 suture for easier mobilization. These sutures should be placed at the tendon insertion site, because this is generally the most secure area; placement of the sutures through the tuberosity itself can result in fragmentation. The lesser tuberosity is mobilized and retracted medially while the greater tuberosity is retracted laterally and superiorly to allow visualization of the articular segment (*Figure 2*).

In four-part fractures, the articular segment is generally devoid of soft-tissue attachments and is easily removed. The coracoacromial ligament should be identified at its coracoid attachment and followed to its acromial attachment. When possible, preserve the ligament because of its potential contribution to anterior-superior stability.

With the articular segment removed and the tuberosities retracted, the glenoid articular surface should be inspected. In most situations, the articular surface of the glenoid is intact. It should be visualized to confirm the absence of pre-existing degenerative changes or acute injury. The axillary nerve can usually be palpated at the anterior-inferior aspect of the glenoid. Continuity of the axillary nerve can be confirmed by the "tug test," which consists of palpation of the nerve as it comes around the humeral neck on the underside of the deltoid and as it passes inferior to the glenoid. A



**Figure 1**  
Incision and Exposure



**Figure 2**  
Exposed Glenoid Face



**Figure 3**  
Insert Reamer



**Figure 4**  
Align Fin to  
Bicipital Groove



**Figure 5**  
Insert Fracture Stem Trial

gentle back and forth “tugging” motion confirms its continuity. At this point, the humerus should be placed in extension to expose the proximal portion of the humeral shaft.

#### HUMERAL PREPARATION

Sequentially ream the intra-medullary canal beginning with the 7mm **Fluted Reamer**, until endosteal cortical contact is achieved (*Figure 3*). To avoid over-reaming, keep in mind the anticipated stem diameter based on pre-operative templating. When using the 7mm Reamer, the notch in the flutes indicate the appropriate depth to guarantee the stem can fit distally. The top of the flutes should be used as the depth marker for all other sizes. This ensures the stem can be fully seated for the larger sizes (the 8.5mm, 10.5mm and 12.5mm fracture stems are 20mm longer than the 6.5mm).

The use of a cement restrictor is based on personal preference; however, an appropriately sized cement restrictor will improve distribution. If a cement restrictor will be used, it is advantageous to place the cement restrictor in the humeral canal after reaming and before the **Fracture Stem Positioning Device** is attached to the humerus to avoid interference with the K-wires.

#### Fracture Stem Trialing

Select the **Fracture Stem Trial** based on the last Reamer fully seated. Ensure that the appropriate stem side is chosen (e.g. “Right” or “Left”).

#### Retroversion—Distal Portion of Bicipital Groove (Visible)

Retroversion is established by aligning the anterior-lateral fin of the Fracture Stem Trial with the posterior aspect of the distal bicipital groove (*Figure 4*). Computational analysis of data from our anatomic study of cadaveric humeri demonstrated that placing the fin in the posterior aspect of the distal bicipital groove established retroversion as accurately as the traditional technique of using a pre-selected fixed angle relative to the epicondylar axis.<sup>1</sup>

#### Retroversion—Distal Portion of Bicipital Groove (Not Visible)

Typically, the distal portion of the bicipital groove is visible but in cases when it is not, the standard technique of retroverting the implant at 20 degrees relative to the forearm should be used. In this case, the surgeon must attach the **Primary Stem Inserter** to the Fracture Stem Trial and screw in the **Retroversion Handle** as shown in *Figure 4*. By aligning the Retroversion Handle with the forearm, the Fracture Stem Trial will be placed in 20 degrees of retroversion (*Figure 5*). A mark should be placed on the humeral cortex that corresponds to the anterior-lateral fin of the implant to maintain 20 degrees of retroversion during implantation.

## HUMERAL HEAD TRIAL AND TRIAL REDUCTION

### Humeral Stem Height

Place the Fracture Stem Trial into the intramedullary canal at the desired height as determined pre-operatively (e.g. templating contralateral shoulder) or based on the surgeon's intra-operative judgment (see "Tips for Establishing Height Intra-Operatively"). Using the Fracture Stem Positioning Device, slide the two pins through the top and bottom suture holes in the anterior-lateral fin of the Fracture Stem Trial. Then place two K-wires (0.062 inches) into the humeral shaft to stabilize the Fracture Stem Positioning Device to the bone. The goal is to secure the K-wires in the cortical bone so choose the widest holes that still align with the humerus. Selecting a middle row allows the surgeon to make +/- 4mm height adjustments during the trial reduction by sliding the Fracture Stem Positioning Device off the K-wires and repositioning it (*Figure 6*).

### Attaching the Replicator to the Plate Trial

Attach the 0mm Fixed Angle Replicator Plate Trial to the trial stem and hand-tighten the captured screw with the Torque Screw Removal Tool (*Figure 7*).

### Humeral Head Trial

As a starting point, choose a **Humeral Head Trial** based on the size of the patient's anatomic Humeral Head. The eccentric position of the Humeral Head should be chosen based on the anatomy and/or soft-tissue tension as assessed during trial reduction of the tuberosities (*Figure 8*).

### Tips for Establishing Height Intra-Operatively

- **PULL-DOWNTEST** – With Humeral Head Trial in place, pull arm distally and the top of the head should be at the top of the glenoid
- **FINGER TEST** – One finger should fit between the greater tuberosity and the acromion
- Piece back the tuberosities to snugly fit under the Humeral Head
- If there is no medial bone comminution and no metaphyseal bone on the head fragment, then the calcar of the Humeral Stem can be placed directly on this medial bone, which will then determine head height.

### Trial Reduction

Trial reduction is a critical part of the procedure, because it defines the parameters needed to obtain a stable construct. After the Humeral Head is reduced onto the glenoid, the greater and lesser tuberosities are pulled into position. The biceps tendon is allowed to fall between the tuberosities. Traction on the tuberosity sutures not only maintains the tuberosities in position, but also provides a more accurate assessment of stability. Self-retaining retractors should be relaxed when assessing soft-tissue tension.




**Figure 6**  
Maintain Height



**Figure 7**  
Attach Replicator Plate



**Figure 8**  
Align Humeral Head Trial

Diameter (mm)	Height (mm)			Offset (mm)	Material
	Short	Tall	Expanded		
38	16	19		0	 Co-Cr
41	16	20		0	
44	17	21		1.5	
47	18	22	26	1.5	
50	19	23	27	1.5	
53	20	24	28	1.5	

**Figure 9**  
Humeral Head Scope



**Figure 10**  
Prepared Humeral Shaft



**Figure 11a**  
Lock Torque-Defining Screw on the Back Table Assembly



**Figure 11b**  
Lock the Torque-Defining Screw *in situ*

Assessment of posterior, inferior and anterior stability should be performed by translating the Humeral Head in each direction. Up to 50 percent of posterior and inferior translation of the Humeral Head on the glenoid is acceptable; however, anterior translation should not exceed 25 percent. If translation is greater, the position of the Humeral Stem should be re-evaluated to confirm that it has not subsided or rotated within the canal.

Varying the thickness of the Humeral Head provides the ability to optimize stability and range of motion (*Figure 9*). If soft-tissue laxity is excessive, a taller Humeral Head may be needed. Conversely, if soft-tissue tension is excessive, a shorter Humeral Head is chosen. In either situation, repeat assessment of stability is required to confirm that the proper components and position have been chosen. When the proper position and component size are confirmed, the trial prosthesis should be removed. Unless otherwise indicated, the short head will be used in the majority of cases.

#### REDUCTION WITH DEFINITIVE IMPLANT

##### Cementing the Fracture Stem

To remove the Fracture Stem Trial, leave the Fracture Stem Positioning Device attached to the humerus and slide the holding pins out of the suture holes in the anterior-lateral fin. Alternatively, if the Positioning Device is not used, the location of the fin can be marked and the height relative to the holes in the fin can be noted and then reproduced with the definitive stem.

Two drill holes are placed through the humeral cortex into the intra-medullary canal. These holes should be placed approximately 1.5 to 2cm distal to the level of the surgical neck, and lateral to the bicipital groove. Two #5 non-absorbable sutures are passed through one drill hole into the intra-medullary canal and then out through the second drill hole (*Figure 10*). These vertical sutures are used for tuberosity fixation. The canal is then irrigated copiously and any loose cancellous bone removed.

Place the definitive stem into the **Back Table Assembly**, attach the 0mm Fixed Angle Replicator Plate and lock the Torque-Defining Screw (*Figure 11a*).

**Note:** When using an offset Replicator Plate, ensure the offset is pointing in the six o'clock position unless anatomic landmarks are available.

Alternatively, the Replicator Plate may be assembled *in situ* (*Figure 11b*).

Formal cement pressurization is avoided to decrease the possibility of humeral-shaft fracture. The intra-medullary canal should be packed with a sponge to obtain adequate drying before cementing. Cement is mixed and injected into the canal with a cement gun.



Insert the final prosthesis into the canal and insert the Fracture Stem Positioning Device's two holding pins through the top and bottom holes of the stem's anterior-lateral fin (*Figure 12*). Ensure the two sutures in the humeral shaft remain mobile and that no cement hardens in the posterior suture handle or medial cerclage suture hole. This will ensure that the prosthesis is inserted at the same height and version as the Fracture Stem Trial.

When the cement is hardened, make certain the Replicator Plate is dry and free of any debris.

#### **Tuberosity Fixation**

Fixation of the tuberosities to the prosthesis and the shaft is critical to the success of the procedure. Proper tuberosity reattachment and secure fixation will enhance the probability of a successful outcome in terms of pain relief, range of motion and overall function.

A grafting window is provided in the anterior-lateral fin to allow tuberosity apposition. Apply cancellous bone from the Humeral Head between the shaft and the tuberosities, and between the tuberosities to facilitate healing and a more anatomic reconstruction. If this is not available, Optecure® bone graft may be used.

#### **Tuberosity Reattachment**

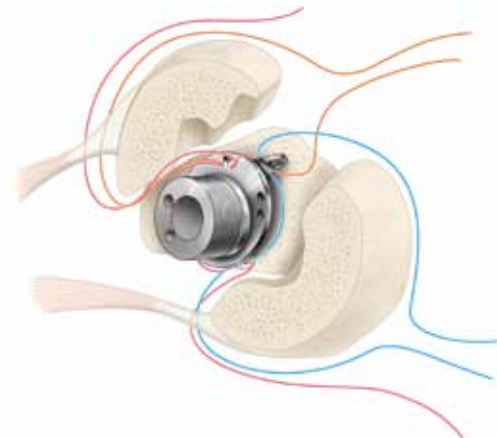
The principles of tuberosity fixation include:

1. two horizontal sutures around each tuberosity to pull the tuberosities to the Humeral Stem (*Figure 13*);
2. placement of one longitudinal suture from the shaft to each tuberosity to bring the tuberosities into a position below the prosthetic articular surface and into contact with the humeral shaft; and
3. one final cerclage suture, which cinches the tuberosities together, and to the Humeral Stem, for added stability.

To secure the tuberosities to the Humeral Stem, we recommend heavy #5 non-absorbable sutures. Tuberosity reattachment should be performed with the arm in approximately 20-degrees of abduction and neutral flexion.

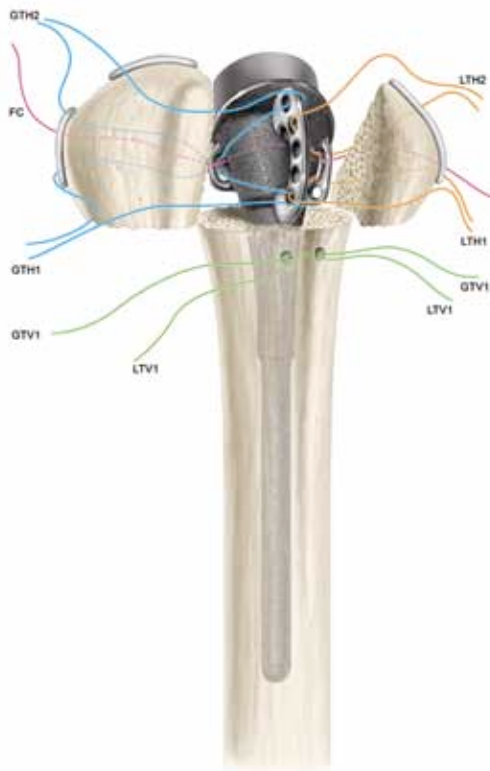


**Figure 12**  
Insert Final Prosthesis



**Figure 13**  
Tuberosity Reattachment





**Suturing Technique 1a, b, c**

### **Suturing Technique for Right Shoulder**

**Suturing Technique 1a:** To reattach the greater tuberosity, pass two horizontal sutures between the greater tuberosity and Humeral Stem. Pass the first suture (First Horizontal suture for the Greater Tuberosity, GTH1) through the lower portion of the infraspinatus tendon where it inserts into the greater tuberosity, through the posterior handle and through an inferior lateral suture hole of the anterior-lateral fin. Pass the second suture (Second Horizontal suture for the Greater Tuberosity, GTH2) through the upper portion of the infraspinatus tendon where it inserts into the greater tuberosity, through the posterior handle and through a superior lateral suture hole of the anterior-lateral fin.

**Suturing Technique 1b:** Pass the final cerclage suture through the middle of the infraspinatus tendon, through the posterior suture handle, around the stem through the medial hole of the fracture stem. Next pass the final cerclage through the anterior handle and through the middle of the subscapularis tendon.

**Suturing Technique 1c:** To reattach the lesser tuberosity, pass two horizontal sutures between the lesser tuberosity and the Humeral Stem. Pass the first suture (First Horizontal suture for the Lesser Tuberosity, LTH1) through the lower portion of the subscapularis tendon where it inserts into the lesser tuberosity, through the anterior handle and through an inferior lateral suture hole of the anterior-lateral fin. Pass the second suture (Second Horizontal suture for the Lesser Tuberosity, LTH2) through the upper portion of the subscapularis tendon where it inserts into the lesser tuberosity, through the anterior handle and through a superior suture hole of the anterior-lateral fin.

### **Humeral Head Attachment**

The final Humeral Head component is placed on the Humeral Stem in the same orientation established in the trialing phase. Impact the Humeral Head using the Impactor directly in line with the taper to ensure proper engagement of the Morse Taper.

### Tying the Sutures

It is important to balance the applied-tension when tying off each suture so as not to displace the tuberosities. First, tie the horizontal sutures for the greater tuberosity when the arm is slightly externally rotated. Second, tie the horizontal sutures for the lesser tuberosity when the arm is placed in neutral rotation.

**Tying the Suture 2a:** Closure includes repair of the rotator interval with #2 non-absorbable sutures. This repair is performed with the humerus in external rotation to decrease the possibility that rotator interval closure will restrict rotation.

**Tying the Suture 2b:** Next, pass and tie the vertical suture (LTV1) through the top upper portion of the subscapularis tendon near the rotator interval where it inserts into the lesser tuberosity.

**Tying the Suture 2c:** Finally, pass and tie the vertical suture (GTV1) through the supraspinatus tendon where it inserts into the greater tuberosity.

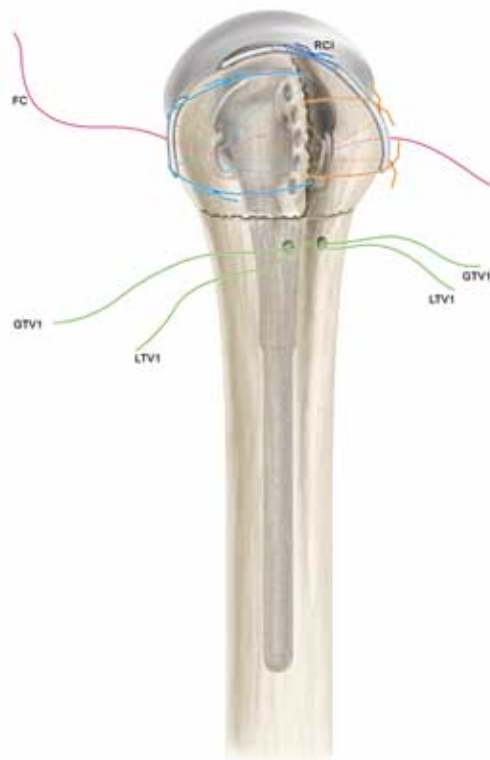
**Tying the Suture 2d:** Once completed, tie the final cerclage.

### Final Stable Reconstruction

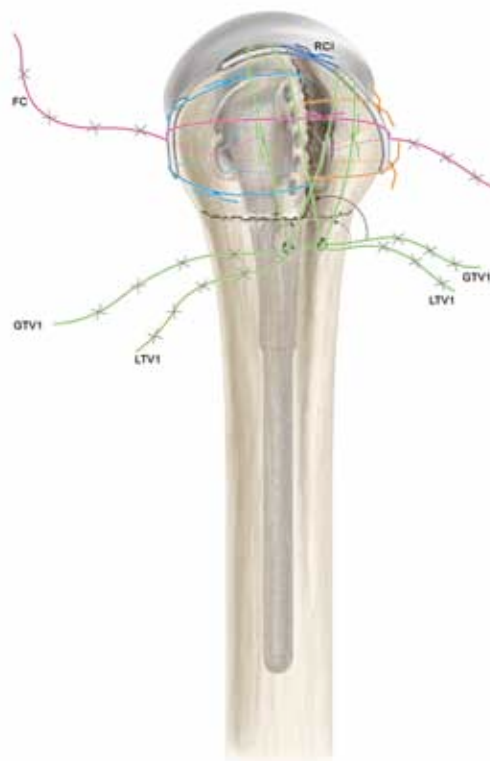
When the tuberosity fixation is completed, the stability of the fixation should be carefully assessed. Range of motion in forward elevation, external rotation, internal rotation and abduction should be performed to determine the specific limits of motion that will be allowed in the post-operative rehabilitation program.

Depending on surgeon preference, a drain may be placed deep into the deltopectoral interval and brought out through the skin distally and laterally. The deltopectoral interval is repaired with an absorbable suture, as is the subcutaneous tissue. Skin closure can be performed with either sutures or staples. A sterile dressing is applied and the upper extremity is placed in a sling.

Radiographs in the operating room are strongly recommended. These should include an A/P view of the shoulder with the humerus in internal rotation (on the chest) and maximum external rotation as defined by the intra-operative assessment. An axillary view is also obtained. These radiographs provide excellent visualization of the position of the prosthesis as well as the position of the tuberosities.



Tying the Sutures



Tying the Sutures 2a, b, c, d



**Humeral Head Attachment**

#### **POST-OPERATIVE REHABILITATION**

It is recommended to initiate the rehabilitation program on the same day as surgery or on post-operative day one. All patients begin active range of motion of the elbow, wrists and hand, and passive range of motion of the shoulder. External rotation should be limited based upon the intra-operative evaluation; internal rotation is allowed to the chest. This is important to avoid any excess stress on the tuberosity repair that could compromise healing. Alternatively, some surgeons will not move the shoulder for three to four weeks post-operatively.

#### **POST-OPERATIVE RANGE OF MOTION**

Exercises are continued for six to eight weeks. Radiographs are obtained approximately two weeks following surgery to confirm the position of the tuberosities. Additional radiographs are obtained at six to eight weeks following surgery to assess the degree of tuberosity healing. If tuberosity healing is sufficient, the sling is discontinued and an active range-of-motion program is begun. At this time patients are encouraged to use their arm for activities of daily living. Passive range-of-motion is continued with gentle stretching to increase overall range. At eight weeks following surgery, isometric deltoid and internal and external rotator strengthening exercises are begun. Vigorous strengthening exercises are not allowed until active forward elevation of at least 90 degrees is obtained. Most patients can expect continued improvement during the first year following surgery, although most recovery will occur during the first six months.

# FRACTURE REVERSE OVERVIEW TECHNIQUE



1A Superolateral Approach



1B Deltpectoral Approach



2 Pilot-Tip Option: Drill Reamer Pilot Hole, Ream the Glenoid and Drill Glenoid Plate Hole



3 Cannulated Option: Insert K-wire, Ream the Glenoid and Drill Glenoid Plate Hole over K-wire



4 Assemble the Glenoid Plate with Bone Graft



5 Insert Glenoid Plate



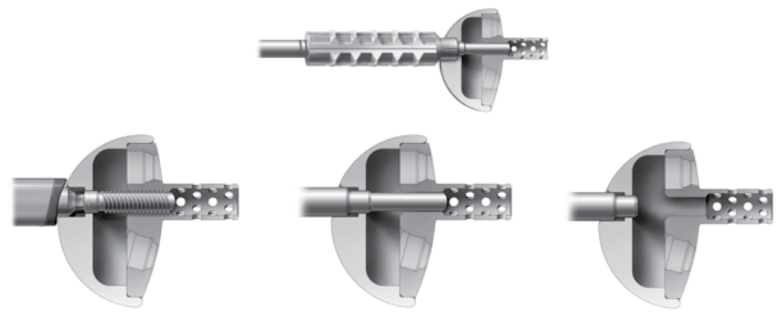
6 Drill Pilot Holes for Compression Screws



7 Insert Compression Screws



**8 Tighten Locking Caps**



**9 Insert Glenosphere Trial**



**10 Glenosphere Trial**



**11 Ream Humeral Canal**



**12 Align Fin to Bicipital Groove**



**13 Position Trial Stem without Bicipital Groove**



**14 Maintain Height**



**15 Attach Humeral Tray Trial to Stem Trial**



**16 Attach Humeral Liner Trial to Trial Tray**



## 2. FRACTURE REVERSE DETAILED OPERATIVE TECHNIQUE

Rotator cuff arthropathy is characterized by glenohumeral arthritis in the presence of a massive and irreparable rotator cuff defect.

### INDICATIONS FOR USE

The Equinox Shoulder System is indicated for use in skeletally mature individuals with degenerative diseases or fractures of the glenohumeral joint where total or hemi-arthroplasty is determined by the surgeon to be the preferred method of treatment.

- The cemented primary humeral stem, long/revision stem, fracture stems and all Equinox glenoids are intended for cemented fixation.
- The press-fit humeral stems are intended for press-fit applications but may be used with bone cement at the discretion the surgeon.
- The reverse humeral components are intended to be used in cemented applications or in revision cases when the humeral component is well-fixed/stable, as deemed by the orthopaedic surgeon.
- Humeral Heads are intended for use in cemented and press-fit applications.

Clinical indications for the PRIMARY (P), LONG/REVISION (L), and FRACTURE (F) humeral components are as follows:

P	L	F	Indications
√	√		Rheumatoid arthritis, osteoarthritis, osteonecrosis or post-traumatic degenerative problems
√	√		Congenital abnormalities in the skeletally mature
√			Primary and secondary necrosis of the humeral head
√		√	Humeral head fracture with displacement of the tuberosities
√	√		Pathologies where arthrodesis or resectional arthroplasty of the humeral head are not acceptable
√	√		Revisions of humeral prostheses when other treatments or devices have failed (where adequate fixation can be achieved)
		√	Displaced three-part and four-part upper humeral fractures
	√		Spiral and other fractures of the mid-humerus (in combination with glenohumeral degenerative diseases)

	√		Revision of failed previous reconstructions when distal anchorage is required
√	√		To restore mobility from previous procedures (e.g. previous fusion)

The Equinox Reverse Shoulder System is indicated for use in skeletally mature individuals with degenerative diseases of the glenohumeral joint and a grossly deficient, irreparable rotator cuff. The Equinox Reverse Shoulder is also indicated for a failed glenohumeral joint replacement with loss of rotator cuff function resulting in superior migration of the humeral head.

The Equinox Platform Fracture Stem is indicated for use in skeletally mature individuals with acute fracture of the proximal humerus and displacement of the tuberosities, displaced three- and four-part fractures of the proximal humerus (hemi-arthroplasty), or acute fracture of the proximal humerus with failure of the glenohumeral joint (primary total shoulder arthroplasty). The Equinox Platform Fracture Stem is also indicated for acute fracture of the proximal humerus in combination with degenerative diseases of the glenohumeral joint and a grossly deficient, irreparable rotator cuff resulting in superior migration of the humeral head (reverse total shoulder arthroplasty). The Equinox Platform Fracture Stem is indicated for cemented use only.

### CONTRAINDICATIONS FOR USE

Use of the Equinox Shoulder System is contraindicated in the following situations:

- Osteomyelitis of the proximal humerus or scapula; if a systemic infection or a secondary remote infection is suspected or confirmed, implantation should be delayed until infection is resolved.
- Inadequate or malformed bone that precludes adequate support or fixation of the prosthesis.
- Neuromuscular disorders that do not allow control of the joint.
- Significant injury to the brachial plexus.
- Non-functional deltoid muscles.
- Patient's age, weight, or activity level would cause the surgeon to expect early failure of the system.
- The patient is unwilling or unable to comply with the post-operative care instructions.
- Alcohol, drug, or other substance abuse.
- Any disease state that could adversely affect the function or longevity of the implant.



## PRE-OPERATIVE PLANNING

After a careful history and physical examination, radiographs should be obtained to assess glenohumeral joint space narrowing, osseous deformities and glenoid wear. A CT scan is helpful to assist in the evaluation of the quality of bone stock and to further evaluate bone deformities that may be present. An MRI may be obtained if further evaluation of the soft tissues is determined to be helpful. To aid in pre-operative planning, radiographic templates are provided for the humeral components and glenoid components to approximate the required size and alignment of the implants.

### PATIENT POSITIONING

The patient should be placed on an operating table in a supine position. The head of the operating table should be elevated approximately 30 degrees in a modified beach chair position. A small bolster should be placed laterally behind the involved shoulder. The patient should be moved to the side of the table so that the upper extremity can be placed in maximum extension without obstruction by the operating table. Alternatively, a Captain's chair or similar positioning device can be used for proper patient positioning. The patient should be secured to the operating table to minimize any changes in position intraoperatively. The entire upper extremity should be prepped and draped to allow complete access to the operative area and full mobility during the procedure. Either a deltopectoral or a superiorlateral approach may be used depending on the surgeon's preference and clinical parameters.

### SURGICAL APPROACH

#### Deltopectoral Approach

A straight deltopectoral incision is made beginning just lateral to the tip of the coracoid process and extending distally and laterally to the insertion of the deltoid. The subcutaneous tissues are divided and medial and lateral flaps are elevated to expose the deeper muscular layers.

The deltopectoral interval is identified by localization of the cephalic vein. The cephalic vein is usually retracted laterally with the deltoid muscle. In some instances the cephalic vein is more easily retracted medially with the pectoralis major. In either case, care should be taken to preserve the cephalic vein throughout the procedure.

The subdeltoid space is mobilized, as is the pectoralis major. The conjoined tendon muscles are identified and the clavipectoral fascia is divided at the medial edge of the conjoined tendon muscles. The fracture hematoma is usually evident after dividing the clavipectoral fascia. The conjoined tendon muscles and the pectoralis major are retracted medially and the deltoid is retracted laterally. This can be most easily accomplished with the use of a self-retaining type of retractor. After the fracture hematoma has been evacuated, the deeper structures can be visualized. The biceps tendon should be identified and tagged with a suture. The biceps tendon provides an orientation to the greater and lesser tuberosities.

#### Superiolateral Approach

A superolateral incision is made beginning at the anterior edge of the acromion and directed posterolaterally in an oblique direction. Subcutaneous dissection is performed to raise generous flaps medially and laterally. The interval between the anterior and middle portions of the deltoid is identified and this interval is developed superiorly over the top of the acromion. In doing so, the anterior deltoid is detached from its acromial attachment along with the coracoacromial ligament insertion. The interval is developed up to 4cm distally from the acromion to avoid potential injury to the axillary nerve. This provides exposure of the subacromial space, which is usually filled with fibrous and bursal tissue that should be removed to expose the humeral head.

The lesser tuberosity is located medial to the biceps tendon and the greater tuberosity is located superiorly and laterally. Each tuberosity should be tagged with a #2 suture for easier mobilization. These sutures should be placed at the tendon insertion site, because this is generally the most secure area; placement of the sutures through the tuberosity itself can result in fragmentation. The lesser tuberosity is mobilized and retracted medially while the greater tuberosity is retracted laterally and superiorly to allow visualization of the articular segment.

In four-part fractures, the articular segment is generally devoid of soft-tissue attachments and is easily removed. The coracoacromial ligament should be identified at its coracoid attachment and followed to its acromial attachment. When possible, preserve the ligament because of its potential contribution to anterior-superior stability.

With the articular segment removed and the tuberosities retracted, the glenoid articular surface should be inspected. In most situations, the articular surface of the glenoid is intact. It should be visualized to confirm the absence of pre-existing degenerative changes or acute injury. The axillary nerve can usually be palpated at the anterior-inferior aspect of the glenoid. Continuity of the axillary nerve can be confirmed by the "tug test", which consists of palpation of the nerve as it comes around the humeral neck on the underside of the deltoid and as it passes inferior to the glenoid. A gentle back and forth "tugging" motion confirms its continuity. At this point, the humerus should be placed in extension to expose the proximal portion of the humeral shaft.

### PREPARING THE GLENOID

#### Glenoid Exposure

Retractors are provided to aid in glenoid exposure. A Posterior Glenoid Retractor (e.g. **Wolfe Retractor**) should be used to displace the proximal humerus posteriorly. A single- or double-spiked glenoid retractor is then placed anteriorly along the glenoid neck. Hohmann Retractors are placed superiorly and inferiorly around the glenoid.

The glenoid labrum is excised circumferentially to expose the entire surface of the glenoid. Any remaining portions of the biceps tendon also should be excised. There is often a significant amount of tissue around the glenoid that represents bursal tissue and remnants of rotator cuff tendons. This should be excised to enhance visualization. The superior,

anterior and inferior capsule should be released both for exposure and mobilization. A posterior capsular release may be beneficial to allow the proximal humerus to be retracted posteriorly for adequate glenoid exposure.

At this point, the degree and location of glenoid erosion can be visualized. This should be carefully and completely assessed so that glenoid reaming can be performed to provide proper orientation of the glenoid component. Exposure of the glenoid also will be facilitated by use of specific retractors. For a deltopectoral approach, a Posterior Glenoid Retractor is essential. The **Forked Retractor** provided in the instrument set can be useful for this purpose. The large **Darrach Retractor** provided can also be used. Levering retractors should be placed anteriorly, superiorly and inferiorly to expose the glenoid margins.

When a superior approach is used, the inferior capsular release is particularly important. The Forked Retractor can then be placed inferiorly to retract the proximal humerus posteroinferiorly for glenoid exposure. Levering retractors should be placed anteriorly, superiorly and posteriorly as described.

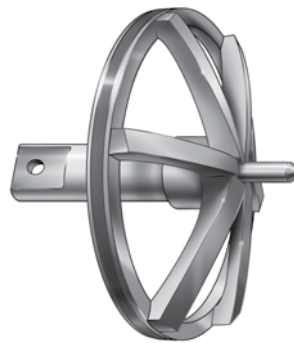
**Note:** While the Equinox Glenoid Plate does not need to be inferiorly tilted or angled, it should not be implanted with a superior tilt. A neutral orientation is ideal.

#### Reaming the Glenoid

The Equinox System provides two options to ream the glenoid: 1) **Pilot-Tip** and 2) **Cannulated Reamers** (Figure 14a, b). Cannulated Reamers rotate about a 0.079 inch K-wire and provide the surgeon maximum precision.

Regardless of the reaming option, the first step is to align the **inferior aspect** of the **Modular Glenoid Plate Drill Guide** with the **inferior aspect** of the native glenoid bone after removing any inferior glenoid osteophytes (Figure 15a, b). This ensures the glenosphere is properly positioned in a superior-inferior position. Palpate the anterior glenoid neck to determine the angle for glenoid reaming.

**Note:** Two handle orientations are offered for the two different surgical approaches.



**Figure 14a**  
Pilot-Tip Reamer



**Figure 14b**  
Cannulated Reamer



**Figure 15a**  
Superolateral Approach

**Figure 15b**  
Deltopectoral Approach



**Figure 16**  
Drill 2mm Pilot Hole

**Figure 17**  
Connect the Modular  
Glenoid Driver

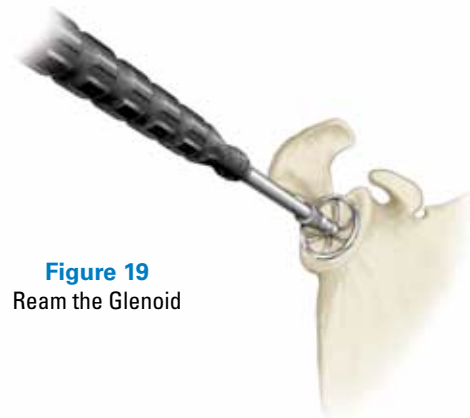


### Pilot-Tip Reamers

If using the Pilot-Tip Reamers, the 2mm pilot hole is drilled to create the central axis for reaming the glenoid (*Figure 16*). The **Reverse Starter Reamer** is provided for each reamer type to aid the surgeon in initial preparation. Connect the Modular Glenoid Driver to the Powered Hand Piece using a Jacobs® Chuck (*Figure 17*). Next, connect the appropriately sized **Modular Reverse Pilot-Tip Reamer** to the **Modular Driver** (*Figure 18*).

The reamer tip is placed into the drilled pilot hole and the glenoid is sequentially reamed until any pre-identified glenoid erosions are corrected and the glenoid surface has been fully contoured (*Figure 19*). Reaming begins with the Reverse Shoulder Starter Reamer and progresses to the 38mm, 42mm and 46mm sizes based upon the anticipated size of the glenosphere. **It is critical to ream to the size of the largest potential glenosphere that the surgeon might use to ensure that the glenosphere will fit on the face of the glenoid without peripheral bony impingement (i.e. the glenoid plate will already be fixed to the glenoid and upsizing the glenosphere during trialing will not be possible if the corresponding reaming has not already been performed).** Reamers are available in color-coded sizes that correspond to the two sizes of Glenospheres as described in *Table 1*.

**Figure 18**  
Connect Modular  
Reverse Pilot-Tip  
Reamer to Glenoid  
Driver



**Figure 19**  
Ream the Glenoid

### Cannulated Reamers

If using the Cannulated Reamers, align the **inferior aspect** of the **Modular Glenoid Plate Drill Guide** with the **inferior aspect** of the native glenoid bone. Drill the 0.079 inch K-wire through the 2mm pilot hole of the Modular Glenoid Plate Drill Guide. Connect the appropriately sized Modular Cannulated Reamer (note that the reamers are color coded) to the Modular Driver (*Figure 20*).

Reaming begins with the Reverse Shoulder Starter Reamer and progresses to the 38mm, 42mm and 46mm sizes based upon the anticipated size of the glenosphere. Sequentially ream the glenoid over the central K-wire until any pre-identified glenoid erosions are corrected and the glenoid surface has been fully contoured (*Figure 21*).

It is critical to ream to the size of the largest potential glenosphere that the surgeon might use to ensure that the glenosphere will fit on the face of the glenoid without peripheral bony impingement (i.e. the glenoid plate will already be fixed to the glenoid and upsizing the glenosphere during trialing will not be possible if the corresponding reaming has not already been performed). Reamers are available in color-coded sizes that correspond to the two sizes of Glenospheres as described in *Table 1* below.

### Drill Cage Hole through Drill Guide

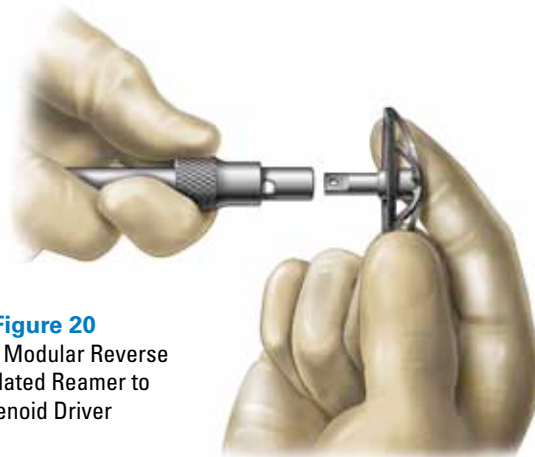
After reaming has been completed, the **inferior aspect** of the Modular Glenoid Plate Drill Guide is realigned with the **inferior aspect** of the glenoid. Connect the **Modular Glenoid Plate Drill** to the **Modular Driver** to prepare the cage hole of the Glenoid Plate (*Figure 22 and 23*). The Glenoid Plate Drill is 7.3mm in diameter. The Glenoid Plate cage is tapered and varies in diameter between 7.5mm at its end to 8.1mm where it joins the back of the Glenoid Plate.

**Note:** *Modular Cannulated Center Peg Drill Option:* After reaming over the 0.079 inch K-wire, drill over the existing K-wire with the Modular Cannulated Center Peg Drill.

### Bone Graft for Glenoid Plate

Two options exist for placing bone graft in the glenoid plate's cage (*Figure 24*).

1. Using the **Glenoid Plate Coring Reamer** to create a 6mm autograft bone column from the humeral



**Figure 20**  
Connect Modular Reverse  
Cannulated Reamer to  
Glenoid Driver



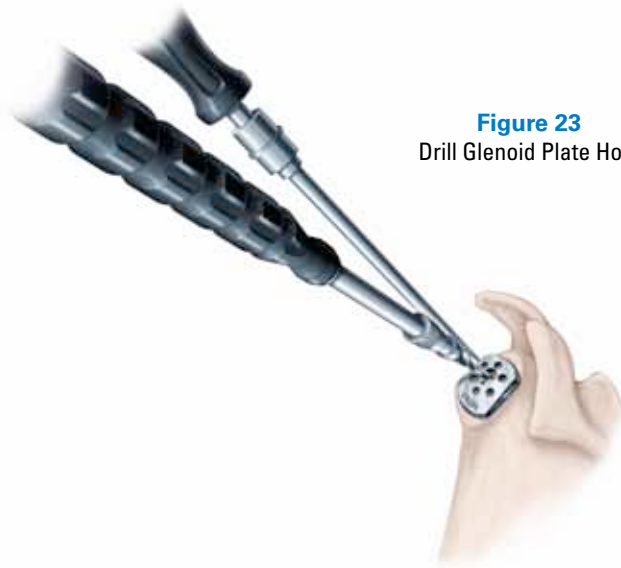
**Figure 21**  
Ream the Glenoid



**Figure 22**  
Connect Modular Glenoid Plate Drill to  
Glenoid Driver

**Table 1 Color-coded Reamers and Trials**

Size	Color of Reamer and Trials
38	Blue
42	Yellow
46	Orange



**Figure 23**  
Drill Glenoid Plate Hole



**Figure 24**  
Assemble Glenoid Plate  
with Bone Graft



**Figure 25**  
Insert Glenoid Plate

head, or other suitable location as deemed appropriate by the surgeon, and inserting the bone column directly into the cage.

2. Placing allograft (e.g. 1cc of either Optecure® with ccc or Optecure in a syringe) or morsalized autograft manually into the cage.

**Note:** Take care to prevent bone graft from getting on the screw-hole threads as this could prevent adequate screw engagement.

#### **Implanting the Glenoid Plate**

Once the cage hole is drilled, the Glenoid Plate is attached to the **Glenoid Plate Inserter** and the Glenoid Plate is press fit into position taking care to respect the correct rotational orientation (**i.e. the plate should align with the superior/inferior axis of the glenoid**) (Figure 25). The Inserter connects to the **bottom half** of the Glenoid Plate such that the central pin aligns with the threaded central hole and the peripheral legs connect to the bottom peripheral holes of the Glenoid Plate.



Four of the six potential screw locations that will provide optimal fixation and support of the glenoid plate are identified. Primary reverse shoulders will most typically use the superior and three inferior holes based on the anatomy of the native glenoid. The two peripheral holes on the superior part of the plate are intended for revision cases in which the native glenoid bone is compromised. However, each case should be individualized and the six holes provide the surgeon with additional options to maximize fixation of the Glenoid Plate (Figure 26).

Four holes should be drilled using the **Adjustable Angle Drill Guide** and the **3.2mm Drill** (Figure 27), taking note of the depth of each hole using either the color-coded drill or the traditional depth guide. Each hole allows 30 degrees of angular variability so the orientation of the screws can be selected to maximize purchase.

**Note:** The central cage of the glenoid plate limits the angular variability to 20 degrees for converging anterior, posterior and superior screws.

The inferior screw should track along the inferior scapular neck and the superior screw should be targeted to track along the base of the coracoids (Figure 28). The anterior and posterior screws should be inserted where the surgeon feels the best bone purchase can be achieved, taking note not to drill into the central cage of the Glenoid Plate.

The 4.5mm **Compression Screws** are provided in lengths between 18mm and 46mm, in 4mm increments. The appropriately sized Compression Screws (Table 2) are inserted into the drilled holes to achieve fixation and compression of the Glenoid Plate to the glenoid. If power is used to initially insert the screws, caution should be taken to perform the final seating by hand. This will maximize fixation. A **Ratcheting Screw Drive** is included in the instrument set to facilitate the placement and tightening of the screws.



**Figure 26**  
Implant Glenoid Plate



**Figure 27**  
Drill Inferior Hole



**Figure 28**  
Implant Screw



**Table 2 Compression Screws**

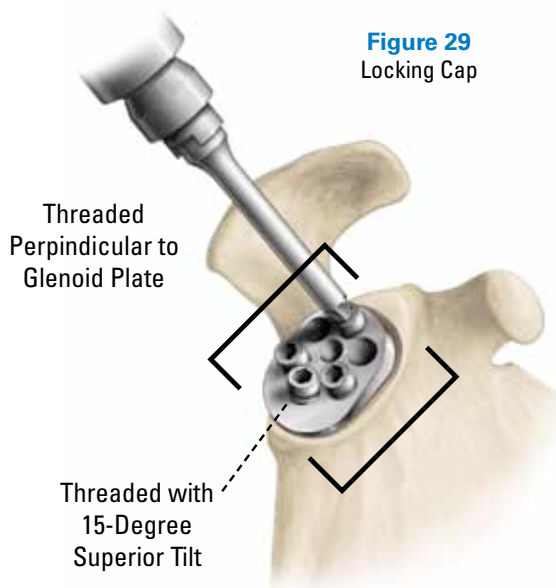
Length (mm)	Diameter (mm)	Color-code
18	4.5	White
22	4.5	Black
26	4.5	Orange
30	4.5	Blue
34	4.5	Red
38	4.5	Green
42	4.5	Yellow
46	4.5	Purple

After all Compression Screws are tightened by hand, as deemed appropriate by the orthopaedic surgeon, the surgeon should insert the **Locking Caps** into each screw hole. This will lock each Compression Screw and prevent the screws from backing out. **Each Locking Cap is inserted perpendicular to the plate with the exception of the inferior one, which must be threaded at a 15-degree superior tilt (Figure 29).**

**Inserting the Glenosphere Trial**

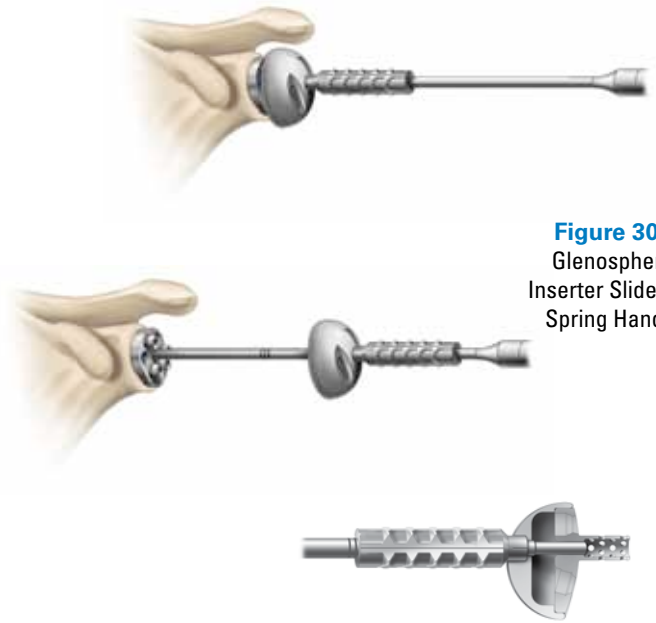
Attaining adequate glenoid exposure is critical for this step, especially posterior glenoid exposure. The Posterior Glenoid Retractor included in the set can help provide the posterior clearance necessary to implant the **Glenosphere**.

The appropriately sized Glenosphere is defined by implanting the largest one that can be inserted based upon exposure and the coracoacromial arch anatomy (ensuring that it was reamed up to that size during the glenoid reaming step). **Take note that unlike circular baseplates, the anatomical shape of the Equinox Glenoid Plate mandates that the Glenosphere can only fit in one specific orientation (i.e. the superior/inferior axis of the glenoid).**



Attach the spring handle to the apical hole of the glenosphere so that rotational control is achieved. Place the pilot tip of the inserter slide through the spring handle and glenosphere and into the baseplate. Three circumferential laser marks (corresponding to the three sizes of glenospheres) are included on the slide to indicate the glenosphere has been fully seated on the baseplate. Additional alignment laser marks are included to help the surgeon maintain the correct orientation of the glenosphere. Maintain digital pressure on the glenosphere while removing the inserter (*Figure 30a*).

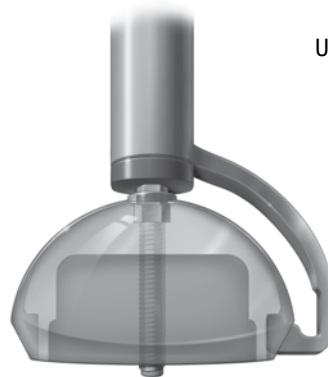
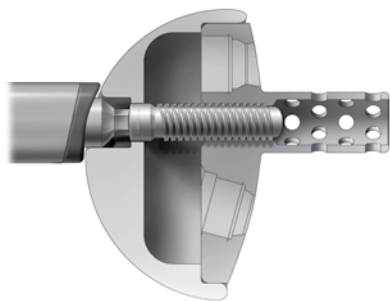
**Universal Glenosphere Inserter Clamp:** To engage the glenosphere, use the hook to grab the anterior cavity of the glenosphere so that rotational control is achieved. The Glenosphere Locking Screw may be inserted prior to engaging the handle or it can be inserted through the handle after it is in place. Once the inserter is attached to the glenosphere, insert the hex drive through the handle to engage the tip of the locking screw. This will hold the glenosphere in place during insertion. The glenosphere can then be maneuvered onto the Glenoid Plate by using the Glenosphere Locking Screw as a guide to the central hole and to ensure it is properly aligned relative to the bone cage. When the glenosphere is fully seated, drive the screw until it locks the assembly together (*Figure 30b*).

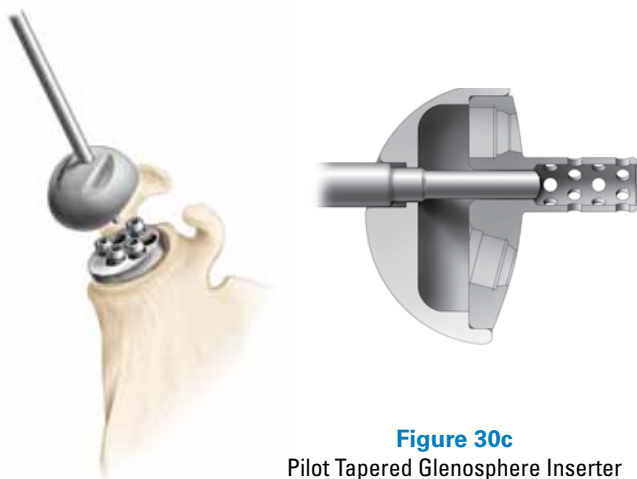


**Figure 30a**  
Glenosphere  
Inserter Slide and  
Spring Handle



**Figure 30b**  
Universal Glenosphere Inserter





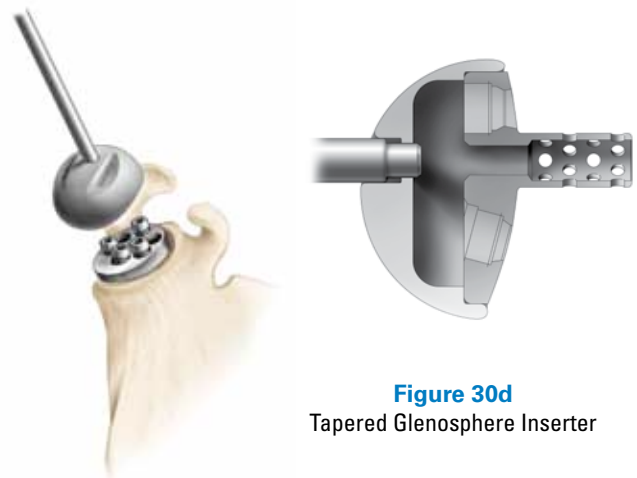
**Figure 30c**  
Pilot Tapered Glenosphere Inserter

**Pilot Tapered Glenosphere Inserter:** Attach the T-Handle to the inserter. Align the T-Handle in the north/south axis of the glenosphere to ensure that it is properly oriented with the Glenoid Plate. The pilot tip fits into the baseplate to aid in orienting the glenosphere onto the baseplate. Once the glenosphere is seated on the baseplate, apply digital pressure to ensure the glenosphere stays on the baseplate and remove the inserter. Do not attempt to impact the Pilot Glenosphere Inserter once the glenosphere is seated (*Figure 30c*).

**Tapered Glenosphere Inserter:** Attach the Tapered Glenosphere Inserter in the same manner as the Pilot Glenosphere Inserter. This instrument provides rotational stability and axial control. Since the instrument is cannulated, a 0.062 inch guide wire or K-wire can be inserted into the bone cage of the Glenoid Plate to aid with insertion (*Figure 30d*).

Finally, the Glenosphere Trial is connected to the Glenoid Plate with the Glenosphere Locking Screw to prevent the Glenosphere from disengaging during trial reductions.

**Note:** When threading the Glenosphere Locking Screw, take note that the hole is not at the apex of the Glenosphere, which can make the screw appear to be going in off axis. The screw is threaded to the baseplate in an orientation that is perpendicular to the baseplate, but this is not perpendicular to the hole in the Glenosphere (*Figure 31*).



**Figure 30d**  
Tapered Glenosphere Inserter



**Figure 31**  
Glenosphere Locking Screw

## HUMERAL PREPARATION

Sequentially ream the intra-medullary canal beginning with the 7mm Fluted Reamer, until endosteal cortical contact is achieved (*Figure 32*). To avoid over-reaming, keep in mind the anticipated stem diameter based on pre-operative templating. When using the 7mm Reamer, the notch in the flutes indicates the appropriate depth to guarantee the stem can fit distally. The top of the flutes should be used as the depth marker for all other sizes. This ensures the stem can be fully seated for the larger sizes (the 8.5mm, 10.5mm and 12.5mm fracture stems are 20mm longer than the 6.5mm).

The use of a cement restrictor is based on personal preference; however, an appropriately sized cement restrictor will improve distribution. If a cement restrictor will be used, it is advantageous to place the cement restrictor in the humeral canal after reaming and before the Fracture Stem Positioning Device is attached to the humerus to avoid interference with the K-wires.

**Note:** Reaming to the notch on the 7mm Reamer will ensure adequate depth for the distal stem if desired height was difficult to determine preoperatively. All other sizes should be reamed to the top of the flutes.

### Fracture Stem Trialing

Select the Fracture Stem Trial based on the last Reamer used. Ensure that the appropriate stem side is chosen (e.g. "Right" or "Left").

### Retroversion—Distal Portion of Bicipital Groove (Visible)

Retroversion is established by aligning the anterior-lateral fin of the Fracture Stem Trial with the posterior aspect of the distal bicipital groove (*Figure 33*). Computational analysis of data from our anatomic study of cadaveric humeri demonstrated that placing the fin in the posterior aspect of the distal bicipital groove established retroversion as accurately as the traditional technique of using a pre-selected fixed angle relative to the epicondylar axis.<sup>1,2</sup>

### Retroversion—Distal Portion of Bicipital Groove (Not Visible)

Typically, the distal portion of the bicipital groove is visible but in cases when it is not, the standard technique of retroverting the implant at 20 degrees relative to the forearm should be used. In this case, the surgeon must attach the Primary Stem Inserter to the Fracture Stem Trial and screw in the Retroversion Handle as shown in *Figure 33*. By aligning the Retroversion Handle with the forearm, the Fracture Stem Trial will be placed in 20 degrees of retroversion (*Figure 34*). A mark should be placed on the humeral cortex that corresponds to the anterior-lateral fin of the implant to maintain 20 degrees of retroversion during implantation.



**Figure 32**  
Ream Humeral Canal



**Figure 33**  
Align Fin to the  
Bicipital Groove



**Figure 34**  
Position Trial Stem



**Figure 35**  
Maintain Height

Place the Fracture Stem Trial into the intramedullary canal at the desired height or based on the surgeon's intra operative judgment. Using the Fracture Stem Positioning Device, slide the two pins through the top and bottom suture holes in the anterior-lateral fin of the Fracture Stem Trial. Then place two K-wires (0.062 inches) into the humeral shaft to stabilize the Fracture Stem Positioning Device to the bone. The goal is to secure the K-wires in the cortical bone so choose the widest holes that still align with the humerus. Selecting a middle row allows the surgeon to make +/- 4mm height adjustments during the trial reduction by sliding the Fracture Stem Positioning Device off the K-wires and repositioning it (Figure 35).

**Trialing the Humeral Adapter Tray and Liner**

The +0mm **Humeral Adapter Tray Trial** is attached to the humeral stem by threading the **Humeral Adapter Tray Captured Screw** into the Humeral Stem's screw hole (Figure 36) (+10mm is also attached this way). It is critical that the Humeral Adapter Tray be oriented such that the line on the Adapter Tray aligns with the lasermarking on the face of the Platform Fracture Stem. The +5mm trial tray can be added as needed. For a +10mm offset and greater, remove the +0mm Humeral Adapter Tray Trial and insert the +10mm tray trial. To obtain a +15mm offset (special order) and larger, the +5mm tray trial will need to be added. Combinations of trays and liners can achieve the following offsets: +0, +2.5, +5.0, +7.5, +10.0, +12.5mm and available by special order +15 and +17.5mm. It is important to note that the assembled humeral component will have a humeral neck angle of 145 degrees because the liner adds 12.5 degrees to the stem's 132.5-degree neck angle (Figure 37).



**Figure 36**  
Attach Humeral Tray Trial to the Stem



**Figure 37**  
Attach Humeral Liner Trial to Trial Tray

To insert the Humeral Liner Trial into the Trial Tray, the underside asymmetric-connecting feature should be appropriately aligned and the liner/tray trials should be pressed together until the C-spring engages. To disengage the trials, the tip of the **Humeral Liner Removal Tool** is inserted into the recessed region of the trial tray and the instrument is turned like a key until the spring that connects the Humeral Liner Trials and plate trials is disengaged, thereby freeing the Liner (*Figure 38*).

The stability of the implant is assessed during a trial reduction. The shoulder should be placed through a range of motion to assess the stability of the construct. While each surgeon may have their own system to assess stability, we approach the trial reduction as follows:

1. With reduction and arm by the side, the lateral deltoid and conjoined tendon should be under tension. The expectation is that the reduction should require more distraction to achieve than reduction of non-constrained implants.
2. Forward elevation and abduction should be assessed to determine that the construct is stable and the components do not impinge on bony structures.
3. Internal and external rotation should be assessed with the humerus at 0 and 90 degrees to assess stability. Although maximal ranges of external rotation may produce some impingement posteriorly, it should not result in instability.
4. With the arm at the side, there should be no evidence of impingement that results in distraction of the implants.

If additional stability is required based upon the trial reduction, constrained liner options are provided in the same offset as the standard liners. While constrained liners will provide better stability, it is important to note they will also reduce the potential range of motion that can be achieved. If tension is inadequate, additional offset can be added up to 12.5mm. If trial components are changed, additional closed reductions and assessments should be performed to confirm that the desired stability has been obtained. In the unusual situation in which the +0mm liner is too tight, the humeral component should be removed and additional bone should be resected using the methods described.

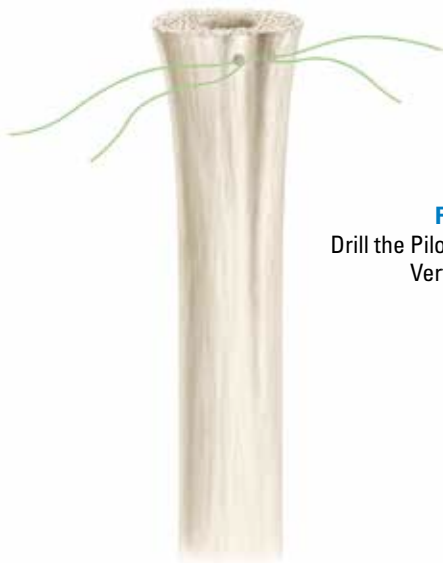


**Figure 38**  
Remove Liner Trial



**Figure 39**  
Attach Final Glenosphere  
to Glenoid Plate





**Figure 40**  
Drill the Pilot Holes for Attaching  
Vertical Sutures



**Figure 41**  
Lock Torque-Defining Screw using  
the Back Table Assembly

## REDUCTION WITH DEFINITIVE IMPLANT

### Cementing the Fracture Stem

To remove the Fracture Stem Trial, leave the Fracture Stem Positioning Device attached to the humerus and slide the holding pins out of the suture holes in the anterior-lateral fin. Alternatively, if the Positioning Device is not used, the location of the fin can be marked and the height relative to the holes in the fin can be carefully noted and then reproduced with the definitive stem.

The Humeral Liner Trial, Humeral Adapter Tray Trial and Glenosphere Trial are removed. The final Glenosphere is implanted in the same manner used with the Glenosphere Trial. Impaction of the Glenosphere is not necessary since it is not a morse taper. The Glenosphere is secured with the Glenosphere Locking Screw, which employs a Spirallock® technology (*Figure 39*).

Two drill holes are placed through the humeral cortex into the intra-medullary canal. These holes should be placed approximately 1.5 to 2cm distal to the level of the surgical neck and lateral to the bicipital groove. Two #5 non-absorbable sutures are passed through one drill hole into the intra-medullary canal and then out through the second drill hole (*Figure 40*). These vertical sutures are used for tuberosity fixation. The canal is then irrigated copiously and any loose cancellous bone removed.

The stem, tray and liner can be assembled using the Back Table Assembly first and then placed as a unit into the humerus with cement. The disadvantage of this technique is that further implant trialing is not possible so it should be used when the surgeon is confident about the thickness of the tray and liners based on the previous trialing. The advantage of this technique is that the shoulder can be reduced and the surgeon can begin closing while the cement is hardening.

When using the Back Table Assembly Stand, place the definitive stem into the Back Table, attach the humeral tray (making certain to align the lasermark on the humeral tray with the mark on the face of the stem) and lock the Torque-Defining Screw (*Figure 41*).

If Back Table Assembly is not used, the final Humeral Liner is attached to the Humeral Tray by orienting the asymmetric connecting features and sliding the lip of the liner under the superior rim of the Humeral Tray. As with the trial insertion, it is important to note that the assembled humeral component will have a humeral neck angle of 145 degrees because the Humeral Liner adds 12.5 degrees to the stem's 132.5-degree neck angle.

Finally, the apical mushroom of the Humeral Liner is engaged to the apical lock of the Humeral Adapter Tray by impacting the Humeral Liner with the appropriately sized **Humeral Liner Impactor Tip** (Table 3). The Humeral Liner should be impacted until it sits flush on the Humeral Adapter Tray (Figure 42).

Insert the Fracture Stem into the canal and insert the Fracture Stem Positioning Device's two holding pins through the top and bottom holes of the stem's anterior-lateral fin. Ensure the two sutures in the humeral shaft remain mobile and that no cement hardens in the posterior suture handle or medial cerclage suture hole. This will ensure that the prosthesis is inserted at the same height and version as the Fracture Stem Trial. Alternatively, if the Positioning Device is not used, the location of the fin can be marked and the height relative to the holes in the fin can be noted and then reproduced with the definitive stem.

Formal cement pressurization is avoided to decrease the possibility of humeral-shaft fracture. The intra-medullary canal should be packed with a sponge to obtain adequate drying before cementing. Cement is mixed and injected into the canal with a cement gun. At this point, the sutures should be preloaded into the stem following the technique outlined previously. Emphasis should be placed on reattaching the greater tuberosity as these muscles are the only source for external rotation.

At this point, the humeral component should be reduced onto the Glenosphere. Range of motion and stability should be assessed to confirm the findings from the trial reduction. Once this assessment has been made, closure can be performed.

Alternatively, *in situ* assembly may be used if the surgeon wishes to retain the ability to trial using the definitive implant. In this case, insert the Fracture Stem into the canal and insert the Fracture Stem Positioning Device's two holding pins through the top and bottom holes of the stem's anterior-lateral fin (Figure 43).

The final Humeral Adapter Tray is attached to the Humeral Stem using the Reverse Torque-Defining Screw (Figure 44). It is critical that the Humeral Adapter Tray be oriented properly, which requires aligning the indicator mark on the tray with the lasermark on the face of the stem. The plate is locked to the stem by applying 11 N\*m torque to the Screw with the supplied driver while countering the torque to the arm with the **Reverse Shoulder Modular Replicator Handle**. The superior portion of the Screw will disengage when 11 N\*m is reached (and will remain in the Screw Drive, both of which are disposable).

**Note:** *In situ* assembly is recommended if the height of the stem cannot be definitively determined with the trial.

**Table 3 Impactor Tips**

Size	Color of Impactor Tips
38	Blue
42	Yellow
46*	Orange

\* special order



**Figure 42**  
Impact Final Humeral Liner onto Humeral Tray



**Figure 43**  
For *in situ* Assembly, Fill the Canal with Cement and Put the Stem in the Canal



**Figure 44**  
Attach Humeral Adapter  
Tray and Lock Reverse  
Torque-Defining Screw



**Figure 45**  
Remove the Glenosphere

## CLOSURE

### DELTOPECTORAL CLOSURE

Depending on surgeon preference, a drain may be used because of the relatively large dead-space and the potential for hematoma formation. The use of a drain will limit the risk of hematoma formation. The deltopectoral interval is closed followed by closure of the subcutaneous tissue and the skin. The upper extremity is then placed in a sling and swathe.

### SUPERIOR-LATERAL CLOSURE

A drain should be inserted to minimize the risk of post-operative hematoma formation. The anterior deltoid should be repaired directly to the anterior acromion with #2 non-absorbable sutures passed through drill holes. The split between the anterior and middle deltoid should be repaired with absorbable sutures. The subcutaneous tissue layer is then closed, followed by the skin closure. The upper extremity is then placed in a sling and swathe.

Radiographs are usually obtained in the operating room to document the position and alignment of the implants. The specific views obtained are based upon surgeon preference.

### GLENOSPHERE REMOVAL

If the Glenosphere needs to be removed, the removal instrument can be used to hook into the anterior and posterior recesses on the underside of the Glenosphere to lever it off of the baseplate (*Figure 45*).

## POST-OPERATIVE REHABILITATION

The rehabilitation program can be carefully started three weeks post-operatively. All patients should begin active range of motion of the elbow, wrist and hand. Range of motion of the shoulder consists of passive and active forward elevation, external rotation based on the intra-operative assessment and internal rotation to the chest wall. Patients should be instructed to perform these exercises five to six times per day for short periods of up to 10 minutes each session.

It is very important that caregivers do not pull up on the operated arm of the patient in an effort to assist the patient from bed or a chair as this might cause dislocation.

The sling is discontinued between two and six weeks. A longer period of sling use is indicated if there is concern about the stability of the joint. When the sling is discontinued, internal rotation behind the back can be started. Gentle resistive strengthening of the deltoid begins 10-12 weeks post-operatively. When the sling is removed, the patient is instructed to increase use of the upper extremity for activities of daily living.

### 3. REVISING A HEMIARTHROPLASTY TO A REVERSE

Gaining exposure to the Glenoid after a hemiarthroplasty, while rarely easy, is facilitated with the Equinox System's removable Replicator Plate. Using the Head Removal Tool, lever the head off the Replicator Plate (*Figure 46*).

When the Torque-Defining Screw was initially torqued, the portion that snapped off left a square that can be used to remove the screw. Attach the Torque-Defining Screw Removal Instrument to the T-handle and loosen the screw (*Figure 47*).

The Replicator Plate can now be removed and discarded. Refer to Section 2: Reverse Shoulder Arthroplasty for detailed Reverse Shoulder technique.



**Figure 46**  
Remove the Humeral Head



**Figure 47**  
Remove the Replicator Plate Tool



## EQUINOXE IMPLANT SCOPE

### Catalog

#### Number Part Description

##### Fracture Stems

304-21-07	Humeral Stem, Fracture, Left, 6.5mm
304-21-09	Humeral Stem, Fracture, Left, 8.5mm
304-21-11	Humeral Stem, Fracture, Left, 10.5mm
304-21-13	Humeral Stem, Fracture, Left, 12.5mm
304-22-07	Humeral Stem, Fracture, Right, 6.5mm
304-22-09	Humeral Stem, Fracture, Right, 8.5mm
304-22-11	Humeral Stem, Fracture, Right, 10.5mm
304-22-13	Humeral Stem, Fracture, Right, 12.5mm
304-23-07	Humeral Long Stem, Fracture, Left, 6.5x200mm
304-24-07	Humeral Long Stem, Fracture, Right, 6.5x200mm



## HEMIARTHROPLASTY IMPLANTS

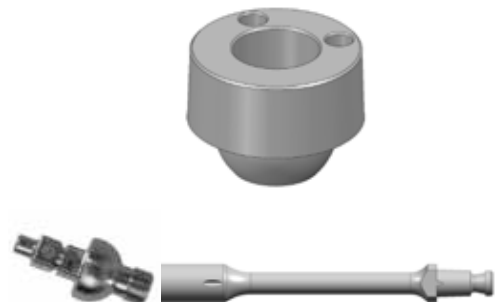
### Humeral Heads

310-01-38	Humeral Head, Short, 38mm
310-01-41	Humeral Head, Short, 41mm
310-01-44	Humeral Head, Short, 44mm
310-01-47	Humeral Head, Short, 47mm
310-01-50	Humeral Head, Short, 50mm
310-01-53	Humeral Head, Short, 53mm
310-02-38	Humeral Head, Tall, 38mm
310-02-41	Humeral Head, Tall, 41mm
310-02-44	Humeral Head, Tall, 44mm
310-02-47	Humeral Head, Tall, 47mm
310-02-50	Humeral Head, Tall, 50mm
310-02-53	Humeral Head, Tall, 53mm
310-03-47	Humeral Head, Expanded, 47mm
310-03-50	Humeral Head, Expanded, 50mm
310-03-53	Humeral Head, Expanded, 53mm



### Replicator Plate Kit

300-21-00	Fixed Angle Replicator Plate Kit, 0mm
-----------	---------------------------------------





**Catalog  
Number**      **Part Description**

**FRACTURE REVERSE IMPLANTS**

**Humeral Adapter Trays**

- 320-10-00      Reverse Shoulder, Humeral Adapter Tray, +0mm
- 320-10-05      Reverse Shoulder, Humeral Adapter Tray, +5mm
- 320-10-10      Reverse Shoulder, Humeral Adapter Tray, +10mm
- 320-10-15\*      Reverse Shoulder, Humeral Adapter Tray, +15mm



**Glenosphere Locking Screw**

- 320-15-05      Reverse Shoulder, Glenosphere Locking Screw
- 320-38-00      Reverse Shoulder, Humeral Liner, 38mm, +0
- 320-38-03      Reverse Shoulder, Humeral Liner, 38mm, +2.5
- 320-38-10      Reverse Shoulder, Constrained Humeral Liner, 38mm, +0
- 320-38-13      Reverse Shoulder, Constrained Humeral Liner, 38mm, +2.5
- 320-42-00      Reverse Shoulder, Humeral Liner, 42mm, +0
- 320-42-03      Reverse Shoulder, Humeral Liner, 42mm, +2.5
- 320-42-10      Reverse Shoulder, Constrained Humeral Liner, 42mm, +0
- 320-42-13      Reverse Shoulder, Constrained Humeral Liner, 42mm, +2.5
- 320-46-00\*      Reverse Shoulder, Humeral Liner, 46mm, +0
- 320-46-03\*      Reverse Shoulder, Humeral Liner, 46mm, +2.5
- 320-46-10\*      Reverse Shoulder, Constrained Humeral Liner, 46mm, +0
- 320-46-13\*      Reverse Shoulder, Constrained Humeral Liner, 46mm, +2.5



**Reverse Torque-Defining Screw Kit**

- 320-20-00      Reverse Shoulder, Torque Defining Screw Kit



**Glenospheres**

- 320-01-38      Reverse Shoulder, Glenosphere, 38mm
- 320-01-42      Reverse Shoulder, Glenosphere, 42mm
- 320-01-46\*      Reverse Shoulder, Glenosphere, 46mm



**Compression Screw/Locking Cap Kits**

- 320-20-18      Reverse Shoulder, Compression Screw/Locking Cap Kit, 4.5 x 18mm, White
- 320-20-22      Reverse Shoulder, Compression Screw/Locking Cap Kit, 4.5 x 22mm, Black
- 320-20-26      Reverse Shoulder, Compression Screw/Locking Cap Kit, 4.5 x 26mm, Orange
- 320-20-30      Reverse Shoulder, Compression Screw/Locking Cap Kit, 4.5 x 30mm, Blue
- 320-20-34      Reverse Shoulder, Compression Screw/Locking Cap Kit, 4.5 x 34mm, Red
- 320-20-38      Reverse Shoulder, Compression Screw/Locking Cap Kit, 4.5 x 38mm, Green
- 320-20-42      Reverse Shoulder, Compression Screw/Locking Cap Kit, 4.5 x 42mm, Yellow
- 320-20-46      Reverse Shoulder, Compression Screw/Locking Cap Kit, 4.5 x 46mm, Purple



**Glenoid Plate**

## EQUINOXE PLATFORM STEM INSTRUMENT LISTING

**Catalog  
Number**

**Part Description**

320-15-01 Reverse Shoulder, Glenoid Plate



### STANDARD PLATFORM FRACTURE INSTRUMENTS

301-03-10 Retroversion Handle



301-07-10 Equinoxe Stem Inserter/Extractor



301-07-30 T-Handle



301-10-10 Torque Defining Screw Removal Instrument



301-10-00 Modular Anatomic Replicator Handle  
301-10-35 Modular Anatomic Replicator Fork



301-15-07 Manual Fluted Reamer, 7mm  
301-15-09 Manual Fluted Reamer, 9mm  
301-15-11 Manual Fluted Reamer, 11mm  
301-15-13 Manual Fluted Reamer, 13mm



305-21-00 Fracture Stem Positioning Device



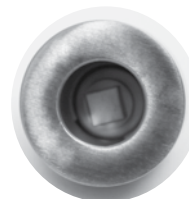
**Catalog  
Number**

**Part Description**

305-21-07	Humeral Stem Trial, Fracture, Left, 6.5mm
305-21-09	Humeral Stem Trial, Fracture, Left, 8.5mm
305-21-11	Humeral Stem Trial, Fracture, Left, 10.5mm
305-21-13	Humeral Stem Trial, Fracture, Left, 12.5mm
305-22-07	Humeral Stem Trial, Fracture, Right, 6.5mm
305-22-09	Humeral Stem Trial, Fracture, Right, 8.5mm
305-22-11	Humeral Stem Trial, Fracture, Right, 10.5mm
305-22-13	Humeral Stem Trial, Fracture, Right, 12.5mm

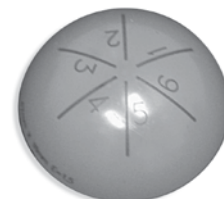


301-25-00	Fixed Angle Replicator Plate Trial
-----------	------------------------------------



**HEMIARTHROPLASTY INSTRUMENTS**

311-01-38	Humeral Head Trial, Short, 38mm
311-01-41	Humeral Head Trial, Short, 41mm
311-01-44	Humeral Head Trial, Short, 44mm
311-01-47	Humeral Head Trial, Short, 47mm
311-01-50	Humeral Head Trial, Short, 50mm
311-01-53	Humeral Head Trial, Short, 53mm



311-02-38	Humeral Head Trial, Tall, 38mm
311-02-41	Humeral Head Trial, Tall, 41mm
311-02-44	Humeral Head Trial, Tall, 44mm
311-02-47	Humeral Head Trial, Tall, 47mm
311-02-50	Humeral Head Trial, Tall, 50mm
311-02-53	Humeral Head Trial, Tall, 53mm

311-03-47	Humeral Head Trial, Expanded, 47mm
311-03-50	Humeral Head Trial, Expanded, 50mm
311-03-53	Humeral Head Trial, Expanded, 53mm

311-05-01	Head Removal Tool
-----------	-------------------



311-07-05	Impactor
-----------	----------



# EQUINOXE PLATFORM STEM INSTRUMENT LISTING

**Catalog  
Number**

**Part Description**

311-07-07 Humeral Head Impactor Tip



## REVERSE SHOULDER INSTRUMENTS

311-01-10 132.5-degree, Fixed Angle Cutting Guide



315-25-00 Modular Glenoid Driver



315-27-60 Modular Center Peg/Keel Drill



315-27-63 Modular Cannulated Center Peg Drill



321-01-25 Glenosphere Inserter



321-01-26 Pilot Glenosphere Inserter



321-01-27 Glenosphere Inserter Slide  
321-01-28 Glenosphere Inserter Spring Handle



321-01-29 Universal Glenosphere Inserter Clamp



321-01-38 Glenosphere Trial, 38mm  
321-01-42 Glenosphere Trial, 42mm  
321-01-46\* Glenosphere Trial, 46mm



321-02-15 Glenosphere Removal Hook



321-07-05 Impactor Handle



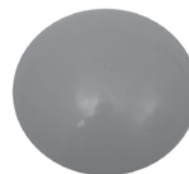
321-07-10 Glenoid Plate Coring Reamer



**Catalog  
Number**

**Part Description**

321-07-38 Humeral Liner Impactor Tip, 38mm  
 321-07-42 Humeral Liner Impactor Tip, 42mm  
 321-07-46\* Humeral Liner Impactor Tip, 46mm\*



321-10-00 Humeral Adapter Tray Trial Assembly, +0  
 321-10-05 Humeral Adapter Tray Trial Assembly, +5  
 321-10-11 Humeral Adapter Tray Trial Assembly, Captured Screw, +10



301-10-00 Modular Anatomic Replicator Handle  
 321-10-35 Reverse Shoulder Modular Replicator Handle



321-15-22 Back Table Frame  
 305-15-00 Back Table Fracture Stem Insert



321-15-30 Modular Glenoid Plate Drill Guide, Left, Superior Lateral  
 321-15-31 Modular Glenoid Plate Drill Guide, Right, Superior Lateral  
 321-15-32 Modular Glenoid Plate Drill Guide, Left, Deltopectoral  
 321-15-33 Modular Glenoid Plate Drill Guide, Right, Deltopectoral



321-15-04 Adjustable Angle Drill Guide



321-20-00 Drill, 2.0mm  
 321-15-06\*\* Drill, 3.2mm  
 321-15-07\*\*



321-15-08 Hex Screwdriver, 3.5mm



321-15-09 Glenoid Screw Depth Gauge



321-15-11 Humeral Liner Removal Tool



## EQUINOXE PLATFORM STEM INSTRUMENT LISTING

**Catalog  
Number**

**Part Description**

321-15-13 Glenoid Plate Inserter/Impactor



321-25-01 Modular Reverse Pilot-Tip Starter Reamer  
 321-25-38 Modular Reverse Pilot-Tip Reamer, 38mm  
 321-25-42 Modular Reverse Pilot-Tip Reamer, 42mm  
 321-25-46\* Modular Reverse Pilot-Tip Reamer, 46mm\*



321-35-01 Modular Reverse Cannulated Starter Reamer  
 321-35-38 Modular Reverse Cannulated Reamer, 38mm  
 321-35-42 Modular Reverse Cannulated Reamer, 42mm  
 321-35-46\* Modular Reverse Cannulated Reamer, 46mm\*



321-38-00 Humeral Liner Trial, +0, 38mm  
 321-38-03 Humeral Liner Trial, +2.5, 38mm  
 321-38-10 Humeral Liner Trial, Constrained, +0, 38mm  
 321-38-13 Humeral Liner Trial, Constrained, +2.5, 38mm

321-42-00 Humeral Liner Trial, +0, 42mm  
 321-42-03 Humeral Liner Trial, +2.5, 42mm  
 321-42-10 Humeral Liner Trial, Constrained, +0, 42mm  
 321-42-13 Humeral Liner Trial, Constrained, 42mm, +2.5



321-46-00\* Humeral Liner Trial, +0, 46mm  
 321-46-03\* Humeral Liner Trial, +2.5, 46mm  
 321-46-10\* Humeral Liner Trial, Constrained, +0, 46mm  
 321-46-13\* Humeral Liner Trial, Constrained, +2.5, 46mm

### RETRACTORS

317-01-08 Wolfe Retractor



317-20-01 Forked Retractor – Small





**Catalog  
Number**

**Part Description**

317-01-03

Darrach Retractor



317-01-06

Hohmann Retractor



317-01-02

Humeral Head Retractor



317-01-04

Dual Point Glenoid Retractor



317-01-05

Single Point Glenoid Retractor



317-20-03

Deltoid Retractor



## REFERENCES

1. **Angibaud L, Zuckerman JD, Flurin PH, Roche C, Wright T.** Reconstructing proximal humeral fractures using the bicipital groove as a landmark. *Clin Orthop Relat Res.* 2007 May; 458:168-74.
2. **Roche C, Flurin PH, Wright T, Crosby LA, Mauldin M, Zuckerman JD.** An evaluation of the relationships between reverse shoulder design parameters and range of motion, impingement, and stability. *J Shoulder Elbow Surg.* 2009 Sep-Oct; 18(5):734-41.





Exactech is proud to have offices and distributors around the globe.  
For more information about Exactech products available in your country, please visit [www.exac.com](http://www.exac.com)

Jacobs® is a registered mark of the Jacobs Chuck Manufacturing Co. and Spiralock® is a registered mark of the Spiralock Corp.

---

For additional device information, refer to the Exactech Shoulder System—Instructions for Use for a device description, indications, contraindications, precautions and warnings. For further product information, please contact Customer Service, Exactech, 2320 NW 66th Court, Gainesville, Florida 32653-1630, USA. (352) 377-1140, (800) 392-2832 or FAX (352) 378-2617.

Exactech, as the manufacturer of this device, does not practice medicine, and is not responsible for recommending the appropriate surgical technique for use on a particular patient. These guidelines are intended to be solely informational and each surgeon must evaluate the appropriateness of these guidelines based on his or her personal medical training and experience. Prior to use of this system, the surgeon should refer to the product package insert for comprehensive warnings, precautions, indications for use, contraindications and adverse effects.

The products discussed herein may be available under different trademarks in different countries. All copyrights, and pending and registered trademarks, are property of Exactech. This material is intended for the sole use and benefit of the Exactech sales force and physicians. It should not be redistributed, duplicated or disclosed without the express written consent of Exactech. ©2012 Exactech.

352-377-1140  
1-800-EXACTECH  
[www.exac.com](http://www.exac.com)



718-02-31 Rev. B  
Platform Fracture Stem Op Technique 0213

*A Great Day in the O.R.™*